

Features

- Two fully independent diodes
- Fully insulated package
- Ultrafast ,soft reverse recovery,with high operation junction temperature (150°C T_j)
- Lo forward voltage drop
- Optimized for power conversion:welding and industrial SMPS applications
- Easy to use and parallel
- Industry standard outline
- Designed and qualified for industrial level

Description

The JK1U/JK2U240-40 insulated modules integrate two state of the art ultrafast recovery rectifiers in the compact, industry standard SOT-227 package. The diodes structure, and its life time control, provide an ultrasoft recovery current shape, together with the best overall performance, ruggedness and reliability characteristics.

These devices are thus intended for high frequency applications in which the switching energy is designed not to be predominant portion of the total energy, such as in th output rectification stage of welding machines, SMPS, DC/DC converters. Their extremely optimized stored charge and low recovery current reduce both over dissipation in the switching elements (and snubbers) and EMI/RFI.

$$I_{FAV}=2\times 120A$$

$$V_{RRM}=400 V$$

$$t_{rr}=90nS$$

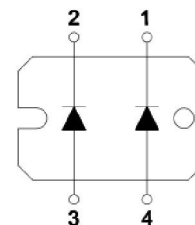

K1

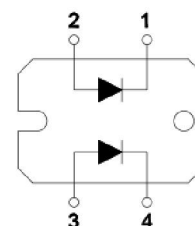

K2

Absolute Maximum Ratings				
Parameters	Symbol	Test Conditions	Max	Unit
Cathode to anode voltage	V _R		400	V
Continuous forward current per diode	I _F	T _C =80°C	120	A
Single pulse forward current per diode	I _{FSM}	T _C =25°C	1200	A
Maximum power dissipation per module	P _D	T _C =90°C	250	W
RMS isolation voltage	Visol	Ac.50Hz; R.M.S; 1min	2500	V
		Ac.50Hz; R.M.S; 1sec	3000	V
Maximum junction temperature	T _J		-55~+150	°C
Maximum case temperature	T _J		150	
Storage temperture	T _{stg}		-55~+150	

JK1U/JK2U240-40

Electrical Specifications						
Parameters	Symbol	Test Conditions	Values			Units
			Min.	Typ.	Max.	
Cathode to anode breakdown voltage	V_{BR}	$I_R=100\mu A$	400	—	—	V
Forward voltage	V_{FM}	$I_F=120 A T_J=25^\circ C$	—	—	1.3	
		$I_F=120 A T_J=125^\circ C$	—	—	1.0	
Reverse leakage current	I_{RM}	$V_R=V_R \text{ rated } T_J=25^\circ C$	—	—	100	μA
		$V_R=V_R \text{ rated } T_J=125^\circ C$	—	—	5	mA

Dynamic Recovery Characteristics ($T_J=25^\circ C$ unless otherwise specified)				
Parameters	Symbol	Test Conditions	Max	Unit
Reverse recovery time	t_{rr}	$I_F=0.5A, I_R=1A, I_{RR}=0.25A$	90	nS
Peak recovery current	I_{RRM}	$I_F=100A, di_F/dt=480A/\mu S, V_R=300V$	27	A

Thermal - Mechanical Specifications						
Parameters	Symbol	Test Conditions	Values			Units
			Min.	Typ.	Max.	
Junction to case ,single leg conducting	R_{thjc}		—	—	0.43	$^\circ C/W$
Junction to case ,both leg conducting			—	—	0.215	
Case to heatsink	R_{thcs}	Flat,greased surface	—	0.05	—	
Mounting Torque	Mt	Mounting torque(M4)	1.1		1.5	Nm
	Ms	Terminal connection torque(M4)	1.1		1.5	
Module(Approximately)	Weight			30		g

Performance Curves

Fig. 1 Forward current I_F versus V_F

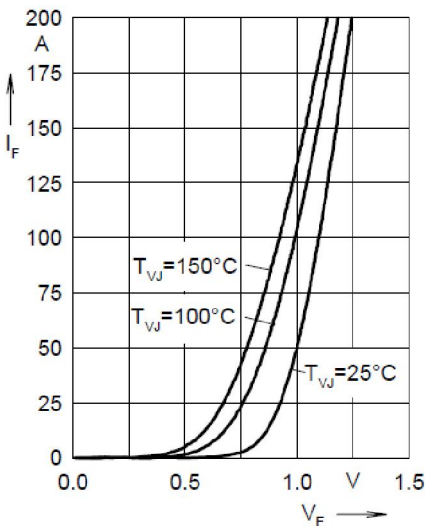

Fig. 2 Reverse recovery charge Q_r versus $-di_F/dt$

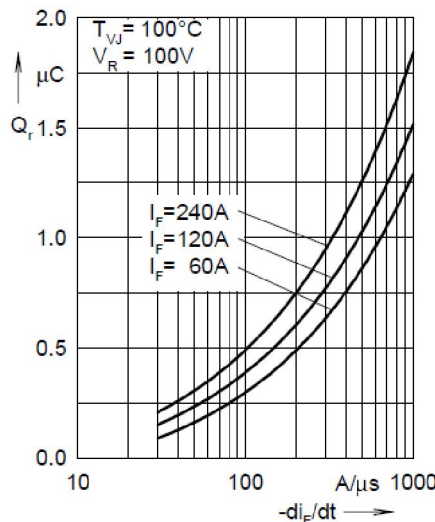
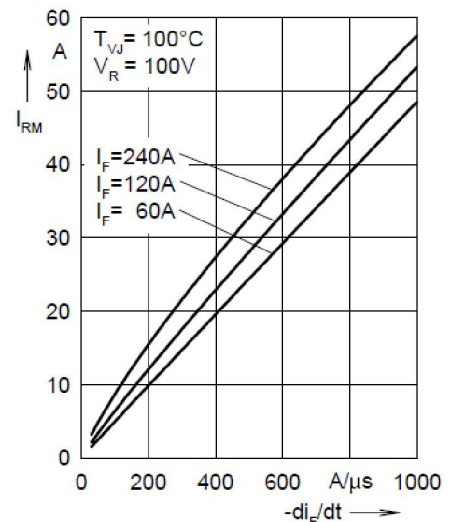

Fig. 3 Peak reverse current I_{RM} versus $-di_F/dt$



JK1U/JK2U240-40

Fig. 4 Dynamic parameters Q_f , I_{RM} versus T_{VJ}

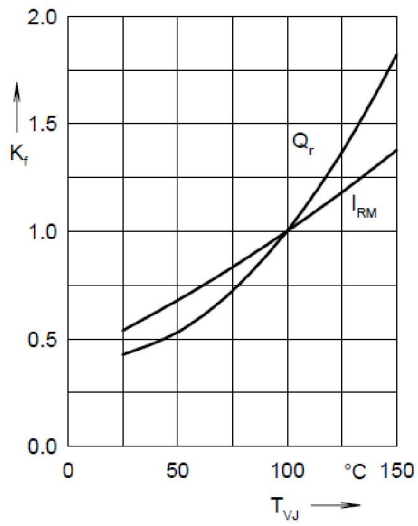

Fig. 5 Recovery time t_{rr} versus $-di_F/dt$

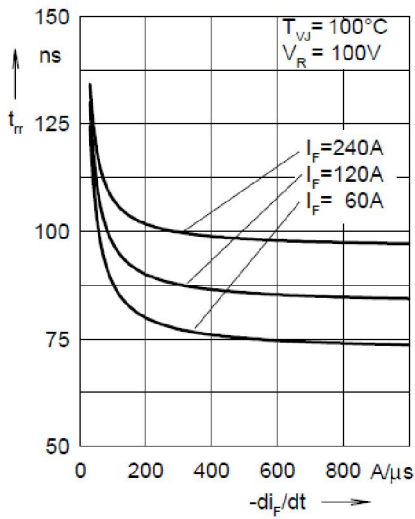

Fig. 6 Peak forward voltage V_{FR} and t_{rr} versus di_F/dt

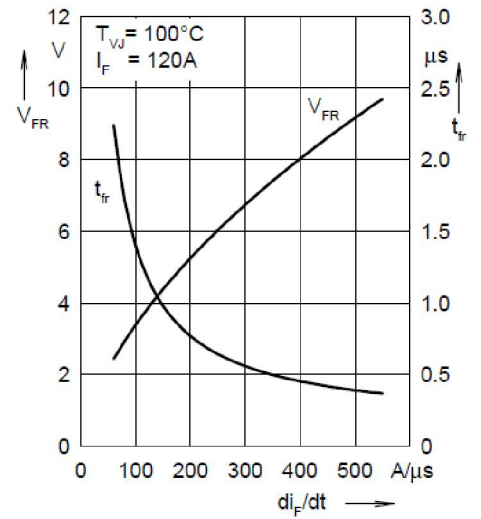
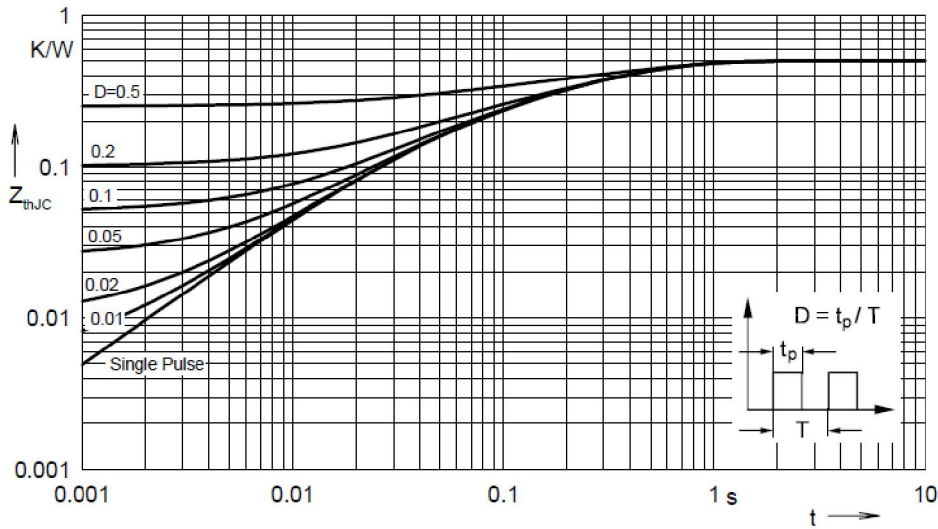

Fig. 7 Transient thermal impedance junction to case at various duty cycles



JK1U/JK2U240-40

Package Outline Information

SOT-227 Package

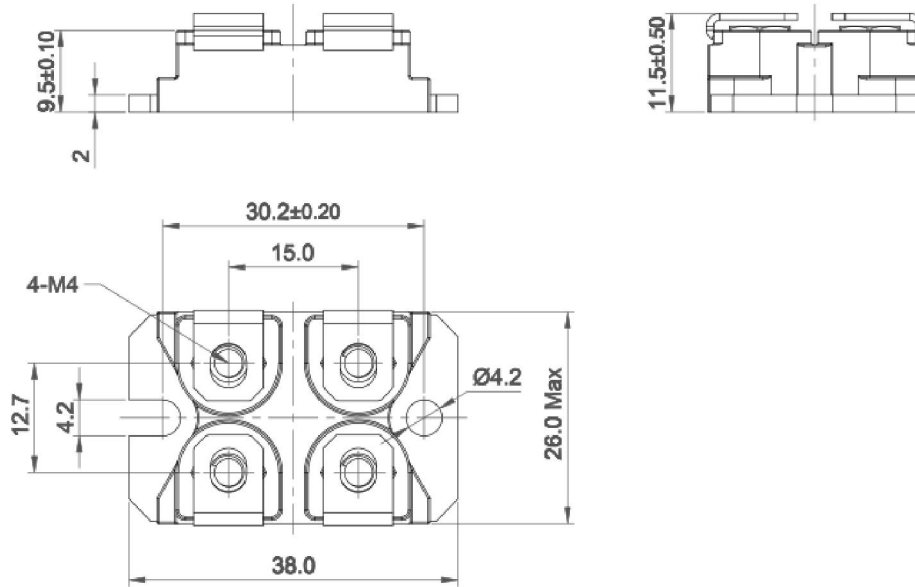

Dimensions in mm