

### FEATURES

- Plastic package has Underwriters Laboratory Flammability Classification 94V-0
- Metal silicon junction ,majority carrier conduction
- Guard ring for overvoltage protection
- Low power loss ,high efficiency
- High current capability ,low forward voltage drop
- High surge capability
- High temperature soldering guaranteed:260°C/10 seconds at terminals
- Component in accordance to RoHS 2015/863/EU



### MECHANICAL DATA

- Case: JEDEC SMA(DO-214AC) molded plastic body
- Terminals: Solder Plated, solderable per MIL-STD-750,method 2026
- Polarity: Color band denotes cathode end
- Weight: 0.002ounce, 0.064 gram

### SMA(DO-214AC)

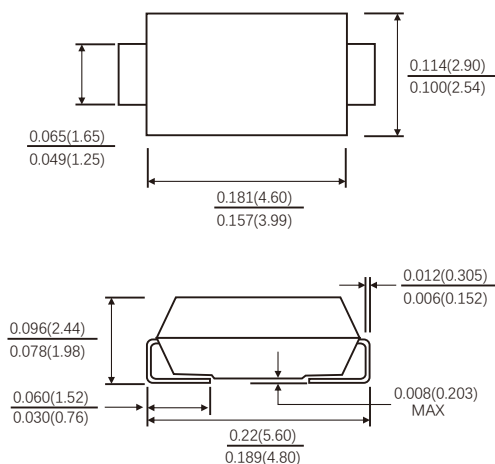

### Suggested PAD Layout

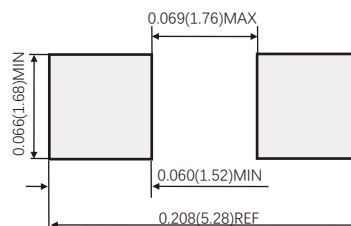

Dimensions in inches and (millimeters)

### TYPICAL APPLICATIONS

For use in low voltage ,high frequency inverters ,DC/DC converters, free wheeling ,and polarity protection applications

### MAXIMUM RATINGS

(Ratings at 25°C ambient temperature unless otherwise specified )

Parameter	Symbol	Value	Unit
Maximum repetitive peak reverse voltage	V <sub>RRM</sub>	40	V
Maximum average forward rectified current	I <sub>F(AV)</sub>	3.0	A
Peak forward surge current 8.3ms single half sine-wave superimposed on rated load (JEDEC method at rated TL)	I <sub>FSM</sub>	80	A
Operating junction temperature range	T <sub>J</sub>	-55 to+150	°C
Storage temperature range	T <sub>stg</sub>	-55 to+150	°C

## ELECTRICAL CHARACTERISTICS (T<sub>A</sub>=25°C Unless otherwise noted)

Parameter	Test Conditions		Symbol	Typ.	Max.	Unit
Instantaneous forward voltage	I <sub>F</sub> =3.0A	T <sub>F</sub> =25°C	V <sub>F</sub> <sup>1)</sup>	0.45	0.47	V
		T <sub>F</sub> =100°C		0.39	0.41	
		T <sub>F</sub> =125°C		0.37	0.39	
Reverse current	V <sub>R</sub> =40V	T <sub>F</sub> =25°C	I <sub>R</sub> <sup>2)</sup>	60	200	μA
		T <sub>F</sub> =100°C		5	10	mA
		T <sub>F</sub> =125°C		15	30	
Typical junction capacitance	4V,1MHz		C <sub>J</sub>	240		pF

Notes: 1.Pulse test: 300 μs pulse width,1% duty cycle

2.Pulse test: pulse width≤40ms

## Thermal Characteristics

Parameter	Symbol	SS34L	Unit
Typical thermal resistance <sup>3)</sup>	R <sub>θJA</sub>	88.0	°C/W
	R <sub>θJL</sub>	28.0	

3.Mounted with 1.0" x 1.0" (25.4 mm x 25.4 mm) copper pad areas 1 oz FR4 Board

## Available Pack Information

Product code	Pack	Reel Size (mm)	Quantity (pcs/reel)	Box Size L×W×H (mm)	Quantity (reel/box)	Carton Size L×W×H (mm)	Quantity (box/carton)
SS34L-SMA	T/R	Φ330	7500	330×35×333	2	364×364×360	8

FIG.1-FORWARD CURRENT DERATING CURVE

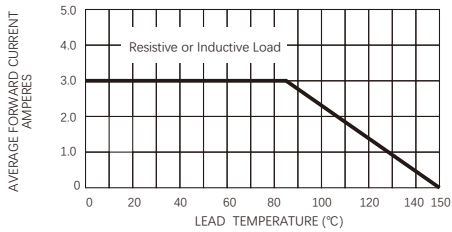

FIG.2-MAXIMUM NON-REPETITIVE PEAK FORWARD SURGE CURRENT

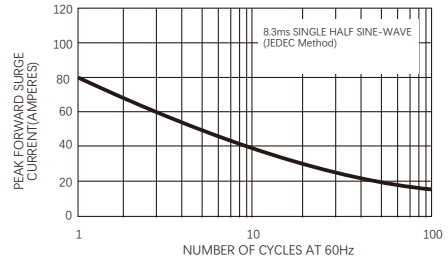

FIG.3-TYPICAL INSTANTANEOUS FORWARD CHARACTERISTICS

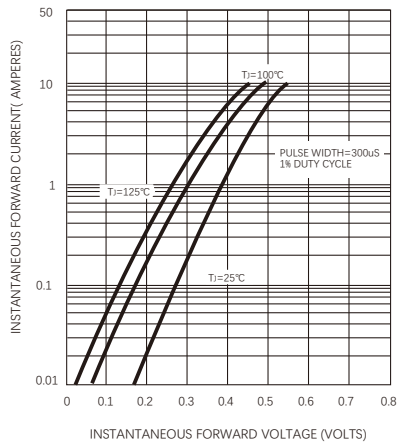

FIG.4-TYPICAL REVERSE CHARACTERISTICS

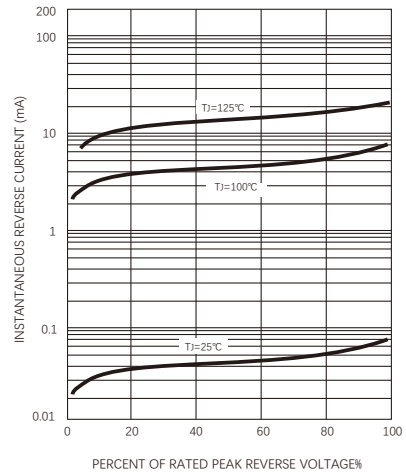
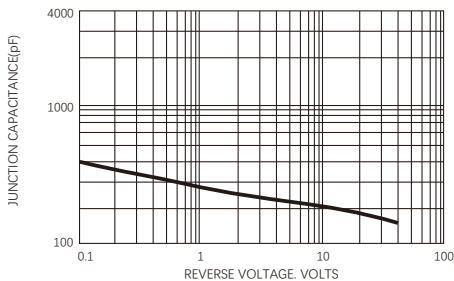

FIG.5-TYPICAL JUNCTION CAPACITANCE



## Friendship Reminder

- JiNan JingHeng(hereinafter referred to as JH) reserves the right to make changes to this document and its products and specifications at anytime without notice.
- Customers should obtain and confirm the latest product information and specifications before final design, purchase or use.
- JH makes no warranty, representation or guarantee regarding the suitability of its products for any particular purpose, nor does JH assume any liability for application assistance or customer product design.
- JH does not warrant or accept any liability with products which are purchased or used for any unintended or unauthorized application.
- No license is granted by implication or otherwise under any intellectual property rights of JH.
- JH's products are not authorized for use as critical components in life support devices or systems without express written approval of JH.