

FEATURES

- Plastic package has Underwriters Laboratory Flammability Classification 94V-0
- Metal silicon junction ,majority carrier conduction
- Guard ring for overvoltage protection
- Low power loss ,high efficiency
- High current capability ,Low forward voltage drop
- High surge capability
- For use in low voltage ,high frequency inverters, free wheeling ,and polarity protection applications
- Dual rectifier construction
- High temperature soldering guaranteed:260 °C/10 seconds, 0.25"(6.35mm)from case
- Component in accordance to RoHS 2015/863/EU

TO-220AB

SR20300CT

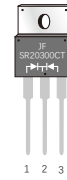

1 2 3

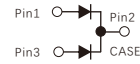

ITO-220AB

SRF20300CT

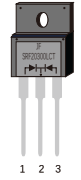

1 2 3

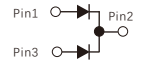

MECHANICAL DATA

- Case: JEDEC TO-220AB/ ITO-220AB/TO-263 molded plastic body
- Terminals: Lead solderable per MIL-STD-750,method 2026
- Polarity: As marked.
- Mounting Position: Any

TO-263

SR20300D1

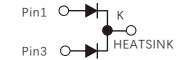
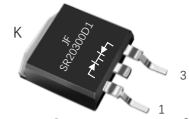

MAXIMUM RATINGS AND ELECTRICAL CHARACTERISTICS

(Ratings at 25°C ambient temperature unless otherwise specified ,Single phase ,half wave ,resistive or inductive load. For capacitive load,derate by 20%.)

Parameters	Symbols	Value				Units
Maximum repetitive peak reverse voltage	VRRM	300				Volts
Maximum RMS voltage	VRMS	210				Volts
Maximum DC blocking voltage	VDC	300				Volts
Maximum average forward rectified current(see Fig.1)	Per leg	10.0				Amps
	Total device	20.0				
Peak forward surge current 8.3ms single half sine-wave superimposed on rated load (JEDEC method)	IFSM	200.0				Amps
Forward voltage at 3.0 A per leg(Notes 1)	VF	T _J =25°C	0.70	MAX.	/	Volts
		T _J =125°C	0.57			
Forward voltage at 10.0 A per leg(Notes 1)		T _J =25°C	0.85	MAX.	0.95	Volts
		T _J =125°C	0.71			
Maximum instantaneous reverse current at rated DC blocking voltage(Notes 1)	IR	T _J =25°C	0.3	MAX.	5	µA
		T _J =125°C	/			
Typical thermal resistance (Notes 2)	R _{θJC}	2.5				°C/W
Operating and Storage temperature range	T _J /T _{STG}	-55 to+150				°C

Notes: 1.Pulse test: 300µs pulse width,1% duty cycle

2.Thermal resistance from junction to case

FIG.1-FORWARD CURRENT DERATING CURVE

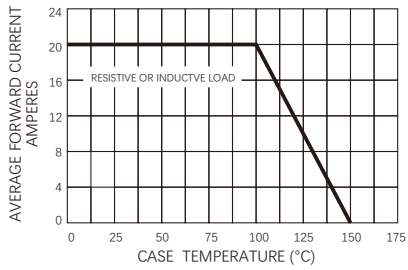

FIG.2-MAXIMUM NON-REPETITIVE PEAK FORWARD SURGE CURRENT

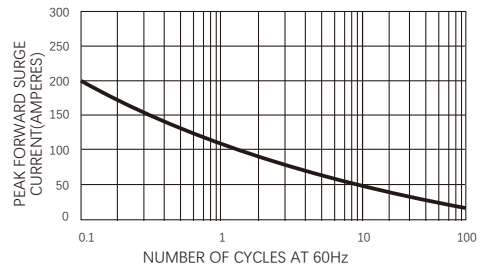

FIG.3-TYPICAL INSTANTANEOUS FORWARD CHARACTERISTICS

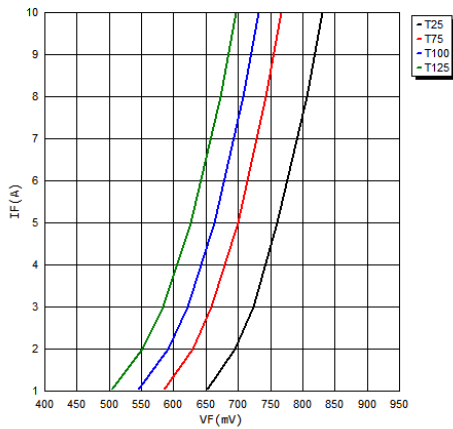
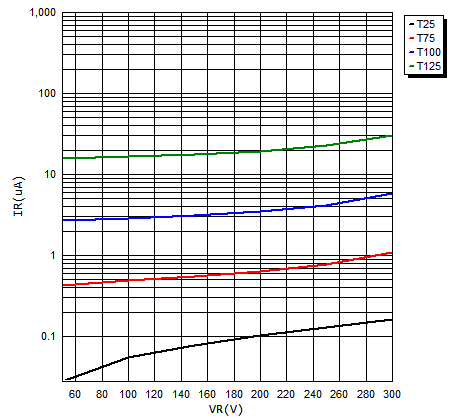
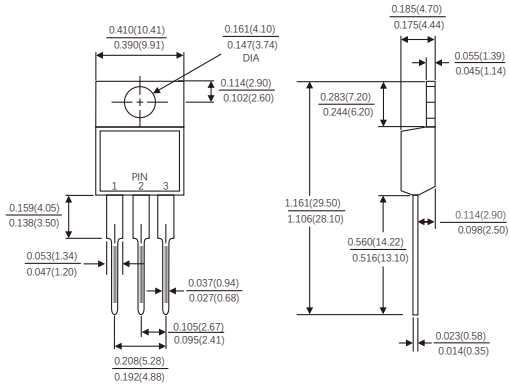

FIG.4-TYPICAL REVERSE CHARACTERISTICS



TO-220AB



ITO-220AB

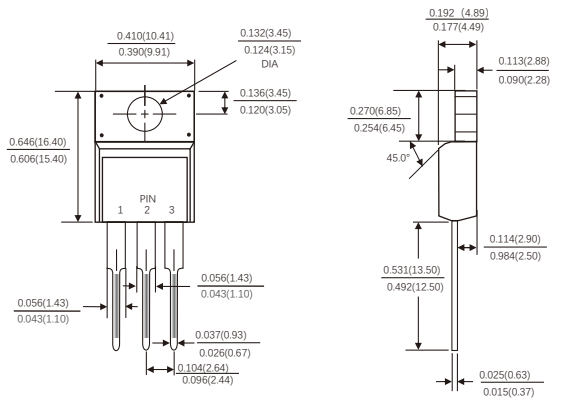

TO-263

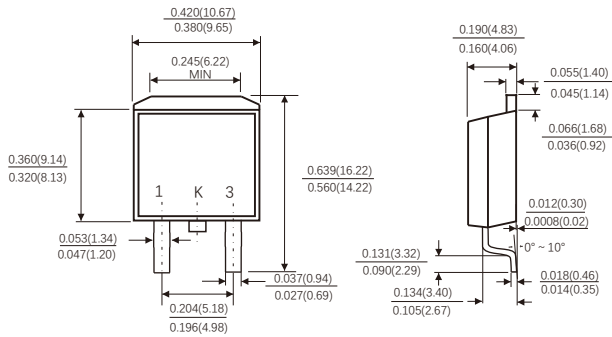

Suggested Pad Layout

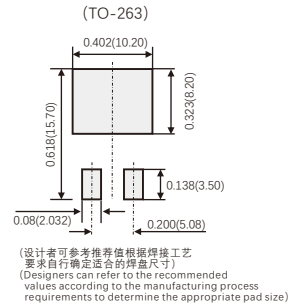

Dimensions in inches and (millimeters)

Friendship Reminder

- JiNan JingHeng (hereinafter referred to as JH) reserves the right to make changes to this document and its products and specifications at anytime without notice.
- Customers should obtain and confirm the latest product information and specifications before final design, purchase or use.
- JH makes no warranty, representation or guarantee regarding the suitability of its products for any particular purpose, nor does JH assume any liability for application assistance or customer product design.
- JH does not warrant or accept any liability with products which are purchased or used for any unintended or unauthorized application.
- No license is granted by implication or otherwise under any intellectual property rights of JH.
- JH' s products are not authorized for use as critical components in life support devices or systems without express written approval of JH.