

FEATURES

- Glass passivated junction
- For Surface Mount Applications, Easy to pick and place
- Plastic package has Underwriters Laboratory Flammability Classification 94V-0
- Low forward voltage drop
- High current capability, High reliability
- Low power loss, high efficiency
- High surge current capability
- High speed switching, Low leakage
- High temperature soldering guaranteed: 260°C/10 seconds at terminals,
- Component in accordance to RoHS 2015/863/EU



SMC(DO-214AB)



Cathode  Anode

MECHANICAL DATA

- Case: JEDEC SMC(DO-214AB) molded plastic body
- Terminals: solder plated, solderable per MIL-STD-750, method 2026
- Polarity: color band denotes cathode end
- Weight: 0.007ounce, 0.21 gram

TYPICAL APPLICATIONS

For use in low voltage, high frequency inverters, DC/DC converters, free wheeling, and polarity protection applications

MAXIMUM RATINGS AND ELECTRICAL CHARACTERISTICS

(Rating at 25°C ambient temperature unless otherwise specified, Single phase, half wave, 60HZ, resistive or inductive load. For capacitive load, derate current by 20%.)

Parameters	Symbols	US5AC	US5BC	US5DC	US5GC	US5JC	US5KC	US5MC	Units
Maximum Repetitive Peak Reverse Voltage	V_{RRM}	50	100	200	400	600	800	1000	V
Maximum RMS Voltage	V_{RMS}	35	70	140	280	420	560	700	V
Maximum DC Blocking Voltage	V_{DC}	50	100	200	400	600	800	1000	V
Maximum Average Forward Rectified Current	I_{FAV}	5.0							A
Peak Forward Surge Current 8.3ms single half sine-wave superimposed on rated load (JEDEC method)	I_{FSM}	150							A
Maximum Instantaneous Forward Voltage at 5.0A	V_F	1.0			1.4	1.7			V
Maximum DC Reverse Current at rated DC blocking voltage	$T_A=25^\circ\text{C}$	5.0							μA
	$T_A=125^\circ\text{C}$	100							
Maximum reverse recovery time(Note1)	t_{rr}	50				75			ns
Typical junction capacitance(Note2)	C_j	49.0							pF
Typical Thermal Resistance(Note3)	$R_{\theta JA}$	47							$^\circ\text{C/W}$
	$R_{\theta JL}$	12							
Operating junction and storage temperature range	T_J, T_{STG}	-55 to +150							$^\circ\text{C}$

Note: 1. Test conditions: $I_F=0.5A, I_R=1.0A, I_{RR}=0.25A$.

2. Measured at 1MHZ and applied reverse voltage of 4.0 Volts.

3. Units mounted on PCB with 0.31" x 0.31" (8.0 mm x 8.0 mm) copper pad areas

FIG.1-TYPICAL FORWARD CURRENT DERATING CURVE

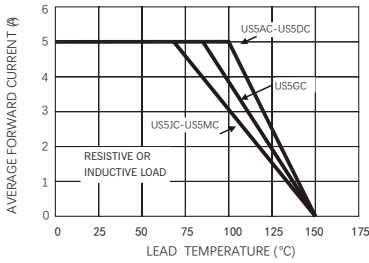

FIG.2-MAXIMUM NON-REPETITIVE FORWARD SURGE CURRENT

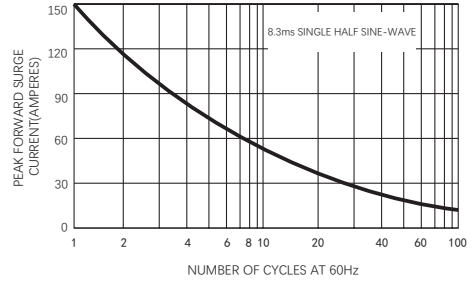

FIG.3-TYPICAL INSTANTANEOUS FORWARD CHARACTERISTICS

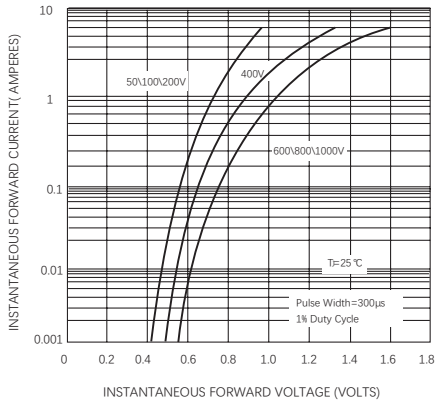

FIG.4-TYPICAL REVERSE CHARACTERISTICS

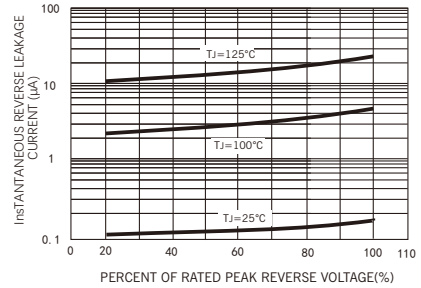

FIG.5-TYPICAL JUNCTION CAPACITANCE

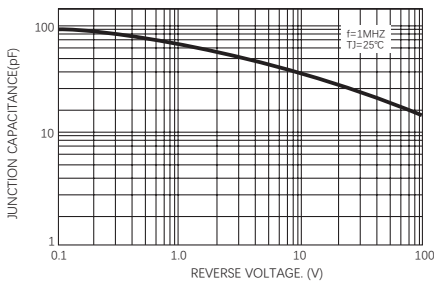
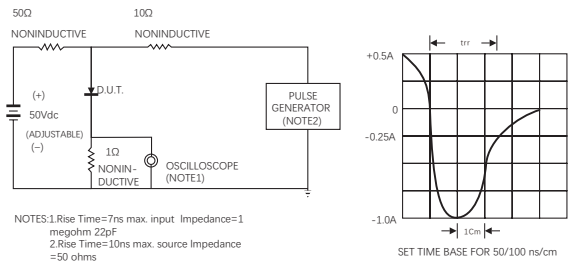

FIG.6-TEST CIRCUIT DIAGRAM AND REVERSE RECOVERY TIME CHARACTERISTIC



AVAILABLE PACK INFORMATION

Product code	Pack	Reel Size (mm)	Quantity (pcs/reel)	Box Size L×W×H (mm)	Quantity (reel/box)	Carton Size L×W×H (mm)	Quantity (box/carton)	Quantity (carton) (K)
US5AC...US5MC-SMC	T/R	Φ330	3000	338×338×39	2	370×370×360	8	48

PACKAGE OUTLINE DIMENSIONS

SMC(DO-214AB)

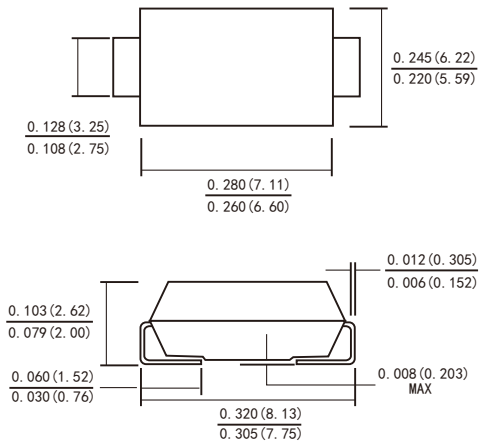

Dimensions in inches and (millimeters)

Suggested PAD Layout

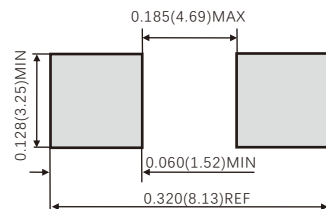

Friendship Reminder

- JiNan JingHeng (hereinafter referred to as JH) reserves the right to make changes to this document and its products and specifications at anytime without notice.
- Customers should obtain and confirm the latest product information and specifications before final design, purchase or use.
- JH makes no warranty, representation or guarantee regarding the suitability of its products for any particular purpose, nor does JH assume any liability for application assistance or customer product design.
- JH does not warrant or accept any liability with products which are purchased or used for any unintended or unauthorized application.
- No license is granted by implication or otherwise under any intellectual property rights of JH.
- JH's products are not authorized for use as critical components in life support devices or systems without express written approval of JH.