

FEATURES

- Plastic package has Underwriters Laboratory Flammability Classification 94V-0
- Metal silicon junction ,majority carrier conduction
- Guard ring for overvoltage protection
- Low power loss ,high efficiency
- High current capability ,low forward voltage drop
- High surge capability
- High temperature soldering guaranteed:260°C/10 seconds at terminals
- Component in accordance to RoHS 2015/863/EU

DO-214AC (SMA)



MECHANICAL DATA

- Case: JEDEC SMA(DO-214AC) molded plastic body
- Terminals: Solder Plated, solderable per MIL-STD-750,method 2026
- Polarity: Color band denotes cathode end
- Weight: 0.002ounce, 0.064 gram

Marking :

JF:Logo

xxxx:Date code

SS210L:Type

TYPICAL APPLICATIONS

For use in low voltage ,high frequency inverters ,DC/DC converters,
free wheeling ,and polarity protection applications

MAXIMUM RATINGS

(Ratings at 25°C ambient temperature unless otherwise specified)

| Parameter | Symbol | Value | Unit |
|--|-------------|------------|------|
| Maximum repetitive peak reverse voltage | V_{RRM} | 100 | V |
| Maximum average forward rectified current (see fig.1) | $I_{F(AV)}$ | 2.0 | A |
| Peak forward surge current 8.3ms single half sine-wave superimposed on rated load (JEDEC method at rated TL) | I_{FSM} | 80 | A |
| Operating junction temperature range | T_J | -55 to+150 | °C |
| Storage temperature range | T_{stg} | -55 to+150 | °C |

RATINGS AND CHARACTERISTIC OF SS210L

ELECTRICAL CHARACTERISTICS (T_A=25°C Unless otherwise noted)

| Parameter | Test Conditions | | Symbol | TYP. | MAX. | Unit |
|------------------------------|----------------------|-----------------------|------------------------------|------|------|------|
| Instaneous forward voltage | I _F =2.0A | T _A =25°C | V _F ¹⁾ | 0.71 | 0.75 | V |
| | | T _A =100°C | | 0.59 | -- | |
| | | T _A =125°C | | 0.55 | -- | |
| Reverse current | V _R =100V | T _A =25°C | I _R ²⁾ | -- | 5 | μA |
| | | T _A =100°C | | -- | 0.5 | mA |
| | | T _A =125°C | | -- | 1.5 | |
| Typical junction capacitance | 4V,1MHz | | C _J | 100 | | pF |

Notes: 1.Pulse test: 300 μs pulse width,1% duty cycle

2.Pulse test: pulse width≤40ms

THERMAL CHARACTERISTICS

| Parameter | Symbol | SS210L | Unit |
|--|------------------|--------|------|
| Typical thermal resistance ³⁾ | R _{θJA} | 88.0 | °C/W |
| | R _{θJL} | 28.0 | |

3. Unit mounted on PC board with 5.0mm×5.0mm (0.013mm thick) copper pads as heat sink

AVAILABLE PACK INFORMATION

| Product code | Pack | Reel Size (mm) | Quantity (pcs/reel) | Box Size L×W×H (mm) | Quantity (reel/box) | Carton Size L×W×H (mm) | Quantity (box/carton) |
|--------------|------|----------------|---------------------|---------------------|---------------------|------------------------|-----------------------|
| SS210L-SMA | T/R | Φ330 | 7500 | 330×35×333 | 2 | 364×364×360 | 8 |

RATINGS AND CHARACTERISTIC OF SS210L

FIG.1-FORWARD CURRENT DERATING CURVE

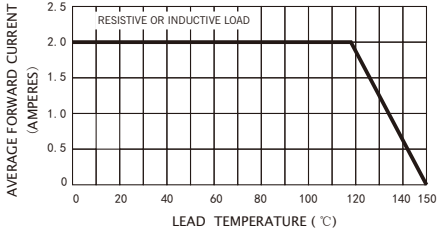

FIG.2-MAXIMUM NON-REPETITIVE PEAK FORWARD SURGE CURRENT

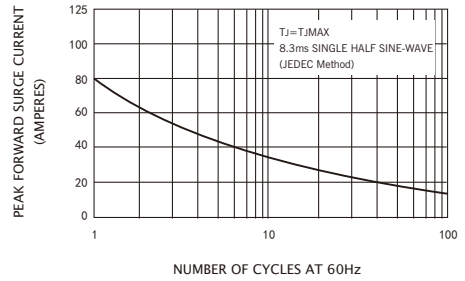

FIG.3-TYPICAL INSTANTANEOUS FORWARD CHARACTERISTICS

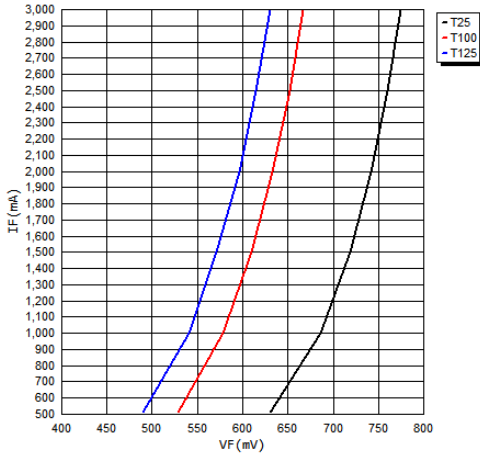

FIG.4-TYPICAL REVERSE CHARACTERISTICS

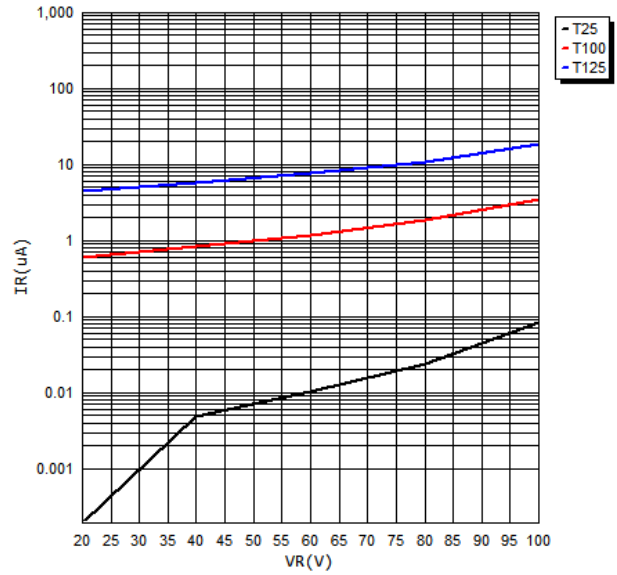
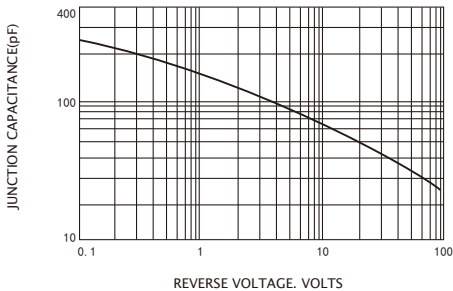

FIG.5-TYPICAL JUNCTION CAPACITANCE



SS210L

PACKAGE OUTLINE DIMENSIONS

SMA(DO-214AC)

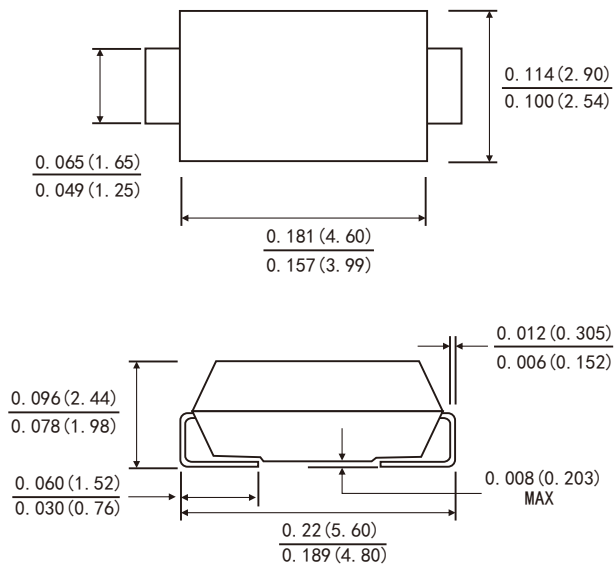

Suggested PAD Layout

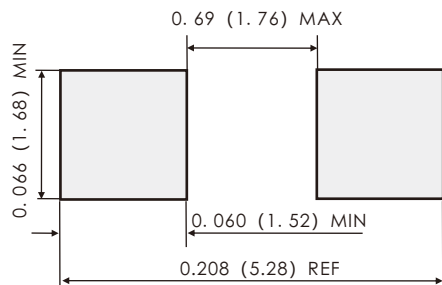

Dimensions in inches and (millimeters)

FriendshipReminder

■ JiNanJingHeng (hereinafterreferredtoasJH) reservestherighttomake changes to this document and its products and specifications at anytime withoutnotice.

济南晶恒（以下简称 JH）保留未经通知，变更本文件和与本文件相关的产品及规格的权利。

■ Customers should obtainandconfirm thelatest product informationand specificationsbeforefinaldesign,purchaseoruse.

使用方应在使用、采购本产品之前获取并确认产品信息和规格书的最新版本。

■ JHmakesnowarranty,representationorguaranteeregardingthesuitability ofitsproductsforanyparticularpurpose,nordoesJHassumeanyliabilityfor applicationassistanceorcustomerproductdesign.

JH 对其产品用于某特定用途的适用性，既不做任何保证、说明或担保，也不承担任何应用协助或使用方设计的法定责任。

■ JH does not warrant or accept any liability with products which are purchasedorusedforanyunintendedorunauthorizedapplication.

JH 不保证或承担任何责任，其产品被采购使用于任何非预期或授权的应用，

■ Nolicense is granted by implication or otherwise under any intellectual propertyrightsofJH.

此规格书属于 JH 的知识产权,没有经过我司授权不得抄袭。

■ JH's products are not authorized for use as critical components in life supportdevicesorsystemswithoutexpresswrittenapprovalofJH.

没有 JH 的书面授权，JH 的产品不能在生命支撑设备或系统里作为关键零件使用。