

### Features

- 100% EAS Guaranteed
- Green Device Available
- Super Low Gate Charge
- Excellent CdV/dt effect decline
- Advanced high cell density Trench technology

### Description

The JHG8048 is the high cell density trenched N-ch MOSFETs, which provide excellent R<sub>DS(on)</sub> and gate charge for most of the synchronous rectification applications.

The JHG8048 meet the RoHS and Halogen-Free compliant product requirement, 100% EAS guaranteed with full function reliability approved.

### Product Summary

BVDSS	R <sub>DS(on)</sub>	I <sub>D</sub>
80V	6.5mΩ	48A

### DFN5X6 Pin Configuration

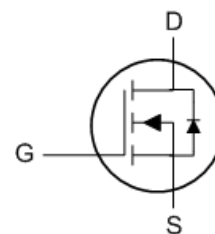
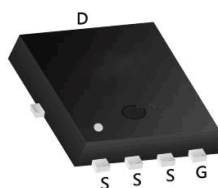

### Absolute Maximum Ratings

Symbol	Parameter	Rating	Units
V <sub>DS</sub>	Drain-Source Voltage	80	V
V <sub>GS</sub>	Gate-Source Voltage	±20	V
I <sub>D</sub> @T <sub>C</sub> =25°C	Continuous Drain Current, V <sub>GS</sub> @ 10V <sup>1,6</sup>	48	A
I <sub>D</sub> @T <sub>C</sub> =100°C	Continuous Drain Current, V <sub>GS</sub> @ 10V <sup>1,6</sup>	42.5	A
I <sub>DM</sub>	Pulsed Drain Current <sup>2</sup>	170	A
EAS	Single Pulse Avalanche Energy <sup>3</sup>	57.8	mJ
I <sub>AS</sub>	Avalanche Current	34	A
P <sub>D</sub> @T <sub>C</sub> =25°C	Total Power Dissipation <sup>4</sup>	56	W
T <sub>STG</sub>	Storage Temperature Range	-55 to 150	°C
T <sub>J</sub>	Operating Junction Temperature Range	-55 to 150	°C

### Thermal Data

Symbol	Parameter	Typ.	Max.	Unit
R <sub>θJA</sub>	Thermal Resistance Junction-Ambient <sup>1</sup>	---	62	°C/W
R <sub>θJC</sub>	Thermal Resistance Junction-Case <sup>1</sup>	---	2.2	°C/W

## Electrical Characteristics (T<sub>J</sub>=25 °C, unless otherwise noted)

Symbol	Parameter	Conditions	Min.	Typ.	Max.	Unit
BV <sub>DSS</sub>	Drain-Source Breakdown Voltage	V <sub>GS</sub> =0V, I <sub>D</sub> =250uA	80	---	---	V
R <sub>DS(ON)</sub>	Static Drain-Source On-Resistance <sup>2</sup>	V <sub>GS</sub> =10V, I <sub>D</sub> =20A	---	4.3	6.5	mΩ
R <sub>DS(ON)</sub>	Static Drain-Source On-Resistance <sup>2</sup>	V <sub>GS</sub> =4.5V, I <sub>D</sub> =20A	---	6.3	8.5	mΩ
V <sub>GS(th)</sub>	Gate Threshold Voltage	V <sub>GS</sub> =V <sub>DS</sub> , I <sub>D</sub> =250uA	1.2	---	2.3	V
I <sub>DSS</sub>	Drain-Source Leakage Current	V <sub>DS</sub> =64V, V <sub>GS</sub> =0V, T <sub>J</sub> =25°C	---	---	1	uA
		V <sub>DS</sub> =64V, V <sub>GS</sub> =0V, T <sub>J</sub> =55°C	---	---	5	
I <sub>GSS</sub>	Gate-Source Leakage Current	V <sub>GS</sub> =±20V, V <sub>DS</sub> =0V	---	---	±100	nA
g <sub>fs</sub>	Forward Transconductance	V <sub>DS</sub> =5V, I <sub>D</sub> =20A	---	75	---	S
R <sub>g</sub>	Gate Resistance	V <sub>DS</sub> =0V, V <sub>GS</sub> =0V, f=1MHz	---	0.5	---	Ω
Q <sub>g</sub>	Total Gate Charge (10V)	V <sub>DS</sub> =40V, V <sub>GS</sub> =10V, I <sub>D</sub> =20A	---	40	---	nC
Q <sub>gs</sub>	Gate-Source Charge		---	7.2	---	
Q <sub>gd</sub>	Gate-Drain Charge		---	6.5	---	
T <sub>d(on)</sub>	Turn-On Delay Time	V <sub>DD</sub> =40V, V <sub>GS</sub> =10V, R <sub>G</sub> =3Ω, I <sub>D</sub> =20A	---	8.3	---	ns
T <sub>r</sub>	Rise Time		---	4.2	---	
T <sub>d(off)</sub>	Turn-Off Delay Time		---	36	---	
T <sub>f</sub>	Fall Time		---	6.9	---	
C <sub>iss</sub>	Input Capacitance	V <sub>DS</sub> =40V, V <sub>GS</sub> =0V, f=1MHz	---	2860	---	pF
C <sub>oss</sub>	Output Capacitance		---	410	---	
C <sub>rss</sub>	Reverse Transfer Capacitance		---	38	---	
<b>Diode Characteristics</b>						
I <sub>S</sub>	Continuous Source Current <sup>1,5</sup>	V <sub>G</sub> =V <sub>D</sub> =0V, Force Current	---	---	48	A
V <sub>SD</sub>	Diode Forward Voltage <sup>2</sup>	V <sub>GS</sub> =0V, I <sub>S</sub> =A, T <sub>J</sub> =25°C	---	0.77	1.0	V
t <sub>rr</sub>	Reverse Recovery Time	I <sub>F</sub> =20A, di/dt=100A/μs, T <sub>J</sub> =25°C	---	27	---	nS
Q <sub>rr</sub>	Reverse Recovery Charge		---	89	---	nC

Note :

- 1.The data tested by surface mounted on a 1 inch<sup>2</sup> FR-4 board with 2OZ copper.
- 2.The data tested by pulsed, pulse width ≤ 300us, duty cycle ≤ 2%
- 3.The EAS data shows Max. rating. The test condition is V<sub>DD</sub>=25V, V<sub>GS</sub>=10V, L=0.1mH, I<sub>AS</sub>=34A
- 4.The power dissipation is limited by 150°C junction temperature
- 5.The data is theoretically the same as I<sub>D</sub> and I<sub>DM</sub>, in real applications, should be limited by total power dissipation.
- 6.The maximum current rating is package limited.

## Typical Characteristics

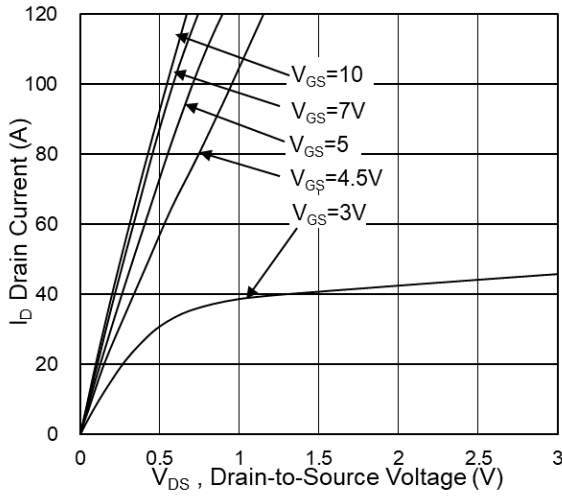

**Fig.1 Typical Output Characteristics**

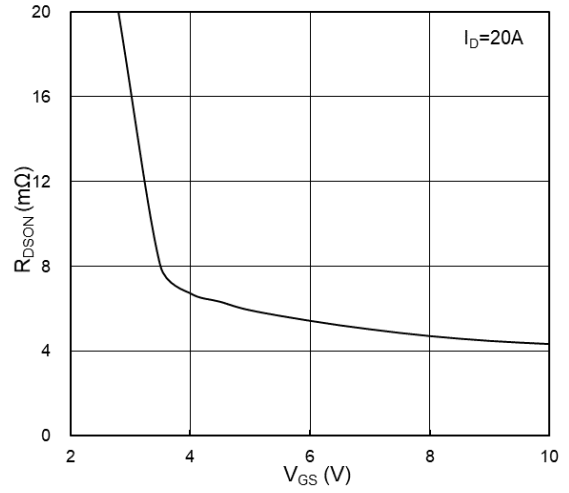

**Fig.2 On-Resistance vs G-S Voltage**

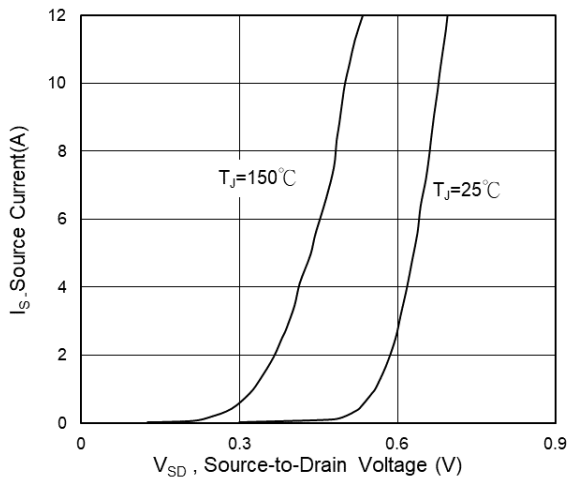

**Fig.3 Source Drain Forward Characteristics**

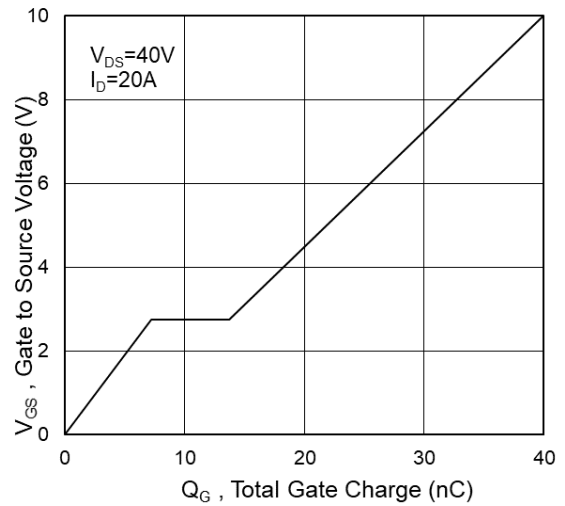

**Fig.4 Gate-Charge Characteristics**

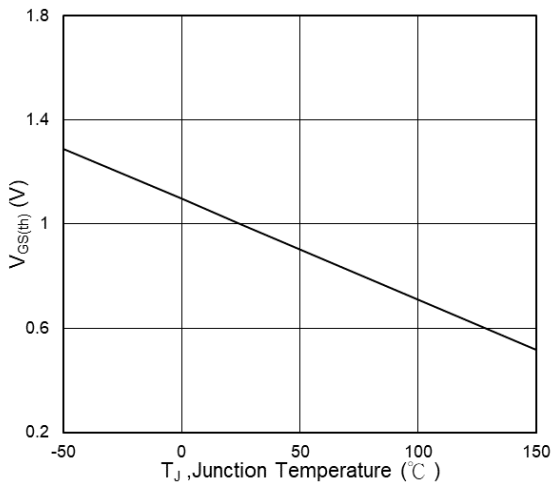

**Fig.5 Normalized  $V_{GS(th)}$  vs.  $T_J$**

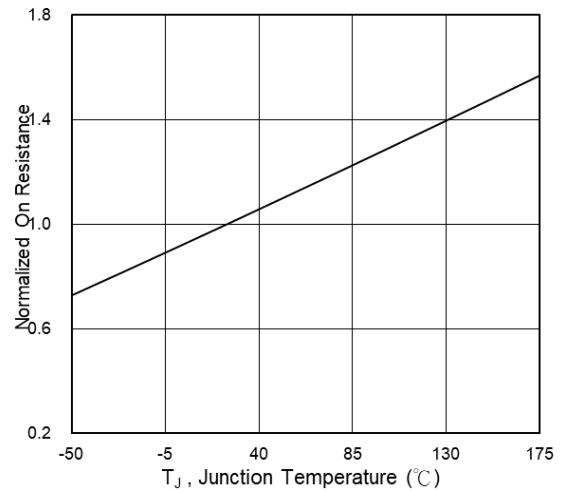

**Fig.6 Normalized  $R_{DSON}$  vs.  $T_J$**

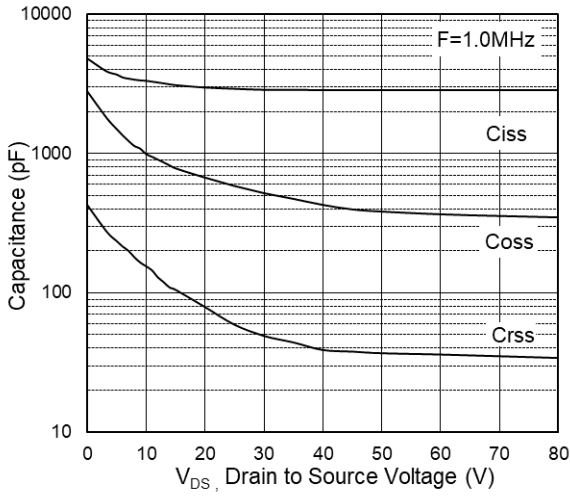

**Fig.7 Capacitance**

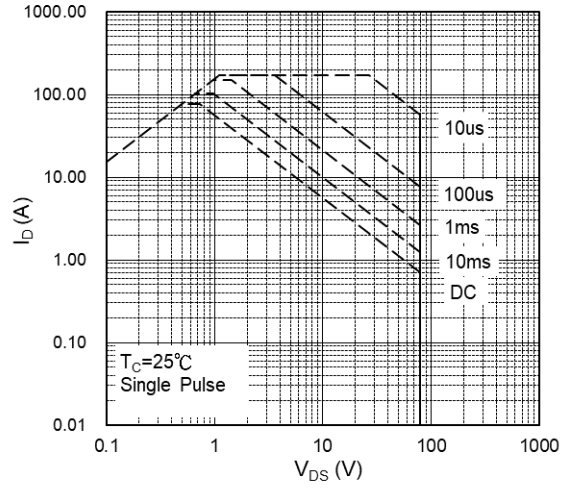

**Fig.8 Safe Operating Area**

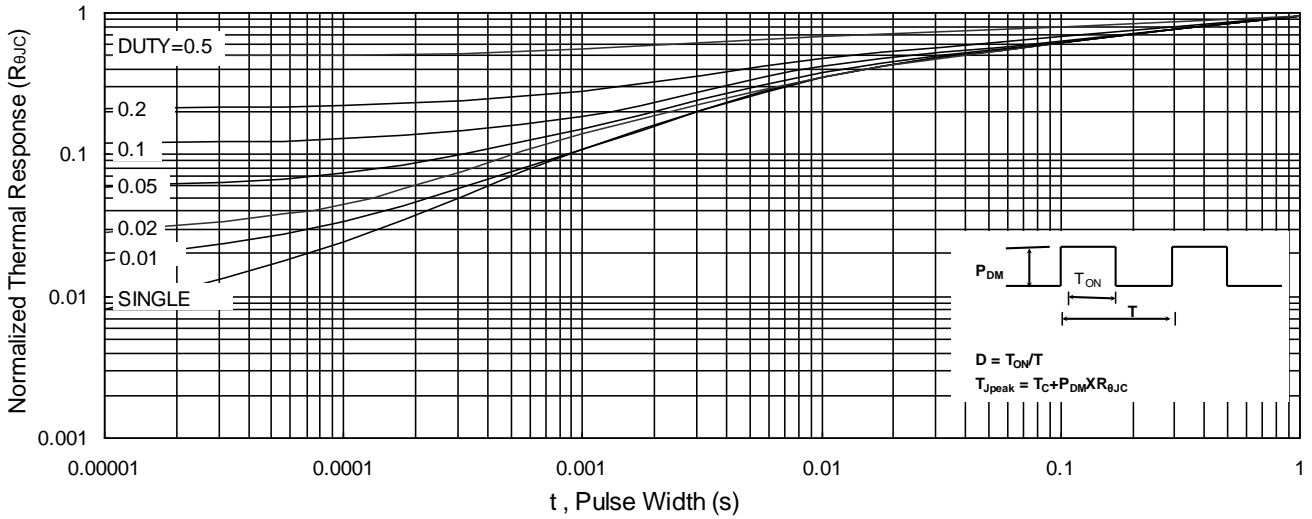

**Fig.9 Normalized Maximum Transient Thermal Impedance**

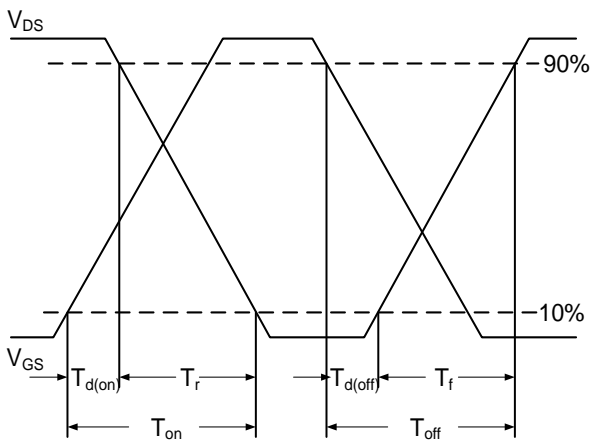

**Fig.10 Switching Time Waveform**

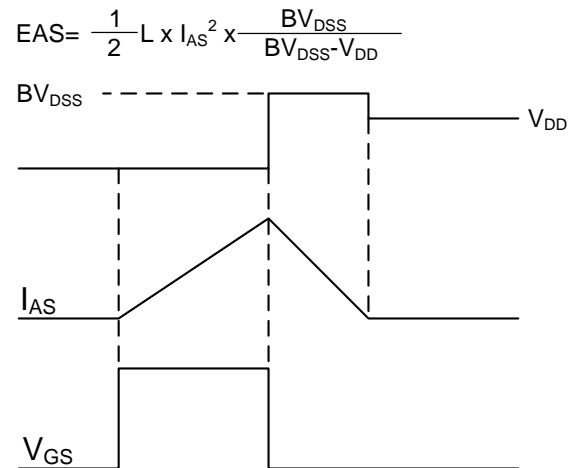

**Fig.11 Unclamped Inductive Switching Waveform**

# JHG8048

## DFN5×6 Outline

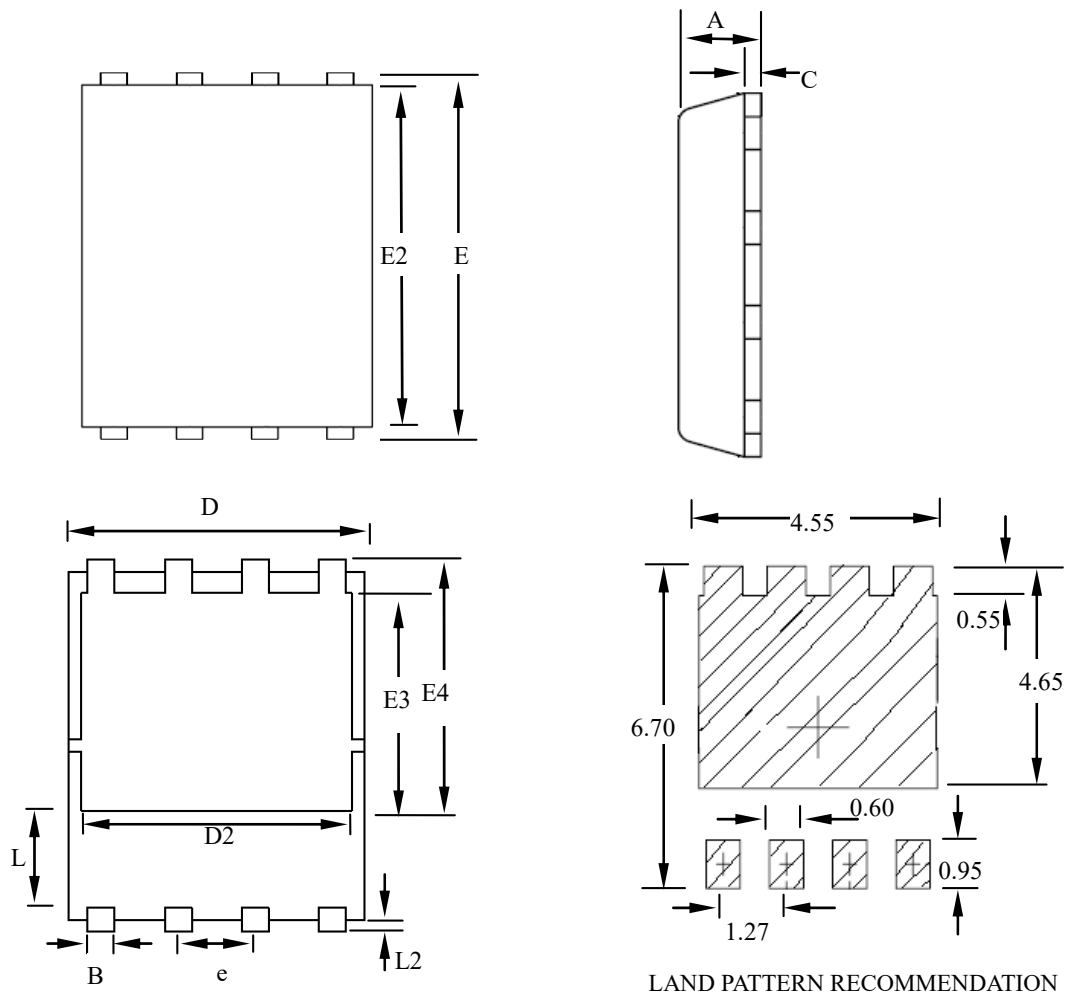

SYMBOLS	MILLIMETERS			INCHES		
	MIN	NOM	MAX	MIN	NOM	MAX
A	0.80	--	1.20	0.031	--	0.047
B	0.30	--	0.51	0.012	--	0.020
C	0.15	--	0.35	0.006	--	0.014
D	4.80	--	5.30	0.189	--	0.209
D2	3.61	--	4.35	0.142	--	0.171
E	5.90	--	6.35	0.232	--	0.250
E2	5.42	--	5.90	0.213	--	0.232
E3	3.23	--	3.90	0.127	--	0.154
E4	3.69	--	4.55	0.145	--	0.179
L	0.61	--	1.80	0.024	--	0.071
L2	0.05	--	0.36	0.002	--	0.014
e	--	1.27	--	--	0.050	--

## Friendship Reminder

■ JiNan JingHeng (hereinafter referred to as JH) reserves the right to make changes to this document and its products and specifications at anytime without notice.

济南晶恒（以下简称 JH）保留未经通知，变更本文件和与本文件相关的产品及规格的权利。

■ Customers should obtain and confirm the latest product information and specifications before final design, purchase or use.

使用方应在使用、采购本产品之前获取并确认产品信息和规格书的最新版本。

■ JH makes no warranty, representation or guarantee regarding the suitability of its products for any particular purpose, nor does JH assume any liability for application assistance or customer product design.

JH 对其产品用于某特定用途的适用性，既不做任何保证、说明或担保，也不承担任何应用协助或使用方设计的法定责任。

■ JH does not warrant or accept any liability with products which are purchased or used for any unintended or unauthorized application.

JH 不保证或承担任何责任，其产品被采购使用于任何非预期或授权的应用，

■ No license is granted by implication or otherwise under any intellectual property rights of JH.

此规格书属于 JH 的知识产权,没有经过我司授权不得抄袭。

■ JH's products are not authorized for use as critical components in life support devices or systems without express written approval of JH.

没有 JH 的书面授权，JH 的产品不能在生命支撑设备或系统里作为关键零件使用。