

Features

- Advanced Trench MOS Technology
- 100% EAS Guaranteed
- Low $R_{DS(ON)}$
- Green Device Available

Product Summary

BVDSS	RDSON	ID
80V	3.0mΩ	100A

Applications

- Power Tools.
- UPS
- Synchronous Rectification in SMPS.

DFN5X6 Pin Configuration

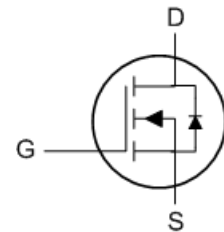
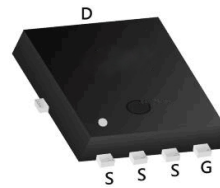

Absolute Maximum Ratings

Symbol	Parameter	Rating	Units
V_{DS}	Drain-Source Voltage	80	V
V_{GS}	Gate-Source Voltage	± 20	V
$I_D@T_C=25^\circ C$	Continuous Drain Current, $V_{GS} @ 10V^{1,6}$	100	A
$I_D@T_C=100^\circ C$	Continuous Drain Current, $V_{GS} @ 10V^{1,6}$	99	A
I_{DM}	Pulsed Drain Current ²	250	A
EAS	Single Pulse Avalanche Energy ³	784	mJ
I_{AS}	Avalanche Current	56	A
$P_D@T_C=25^\circ C$	Total Power Dissipation ⁴	125	W
T_{STG}	Storage Temperature Range	-55 to 150	$^\circ C$
T_J	Operating Junction Temperature Range	-55 to 150	$^\circ C$

Thermal Data

Symbol	Parameter	Typ.	Max.	Unit
$R_{\theta JA}$	Thermal Resistance Junction-Ambient ¹	---	55	$^\circ C/W$
$R_{\theta JC}$	Thermal Resistance Junction-Case ¹	---	1	$^\circ C/W$

JHG8074A

Electrical Characteristics (T_J=25 °C, unless otherwise noted)

Symbol	Parameter	Conditions	Min.	Typ.	Max.	Unit
BV _{DSS}	Drain-Source Breakdown Voltage	V _{GS} =0V, I _D =250μA	80	---	---	V
R _{DS(ON)}	Static Drain-Source On-Resistance ²	V _{GS} =10V, I _D =20A	---	2.3	3.0	mΩ
V _{GS(th)}	Gate Threshold Voltage	V _{GS} =V _{DS} , I _D =250μA	2	2.8	4	V
I _{DSS}	Drain-Source Leakage Current	V _{DS} =64V, V _{GS} =0V, T _J =25°C	---	---	1	μA
		V _{DS} =64V, V _{GS} =0V, T _J =55°C	---	---	5	
I _{GSS}	Gate-Source Leakage Current	V _{GS} =±20V, V _{DS} =0V	---	---	±100	nA
R _g	Gate Resistance	V _{DS} =0V, V _{GS} =0V, f=1MHz	---	1.4	---	Ω
Q _g	Total Gate Charge	V _{DS} =64V, V _{GS} =10V, I _D =20A	---	104	---	nC
Q _{gs}	Gate-Source Charge		---	23.8	---	
Q _{gd}	Gate-Drain Charge		---	28.9	---	
T _{d(on)}	Turn-On Delay Time	V _{DD} =40V, V _{GS} =10V, R _G =3Ω, I _D =20A	---	22	---	ns
T _r	Rise Time		---	16	---	
T _{d(off)}	Turn-Off Delay Time		---	54	---	
T _f	Fall Time		---	16	---	
C _{iss}	Input Capacitance	V _{DS} =40V, V _{GS} =0V, f=1MHz	---	6286	---	pF
C _{oss}	Output Capacitance		---	1108	---	
C _{rss}	Reverse Transfer Capacitance		---	50	---	
Diode Characteristics						
I _S	Continuous Source Current ^{1,6}	V _G =V _D =0V, Force Current	---	---	100	A
V _{SD}	Diode Forward Voltage ²	V _{GS} =0V, I _S =1A, T _J =25°C	---	---	1.2	V

Note :

- 1.The data tested by surface mounted on a 1 inch² FR-4 board with 2OZ copper.
- 2.The data tested by pulsed , pulse width ≤ 300us , duty cycle ≤ 2%
- 3.The EAS data shows Max. rating . The test condition is V_{DD}=50V,V_{GS}=10V,L=0.5mH,I_{AS}=56A
- 4.The power dissipation is limited by 150°C junction temperature
- 5.The data is theoretically the same as I_D and I_{DM} , in real applications , should be limited by total power dissipation.
- 6.Package limitation current is 100A.

Typical Characteristics

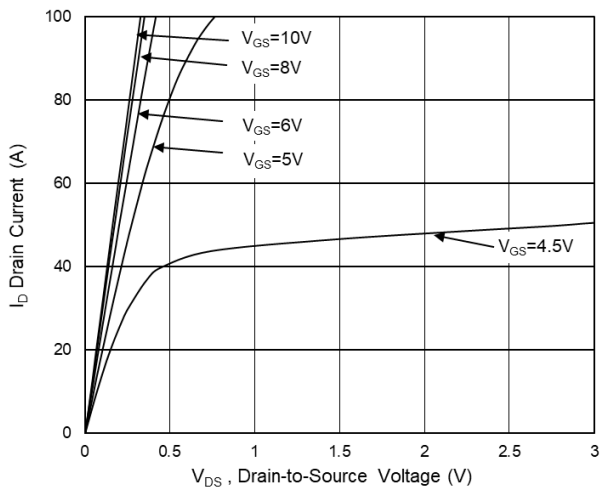

Fig.1 Typical Output Characteristics

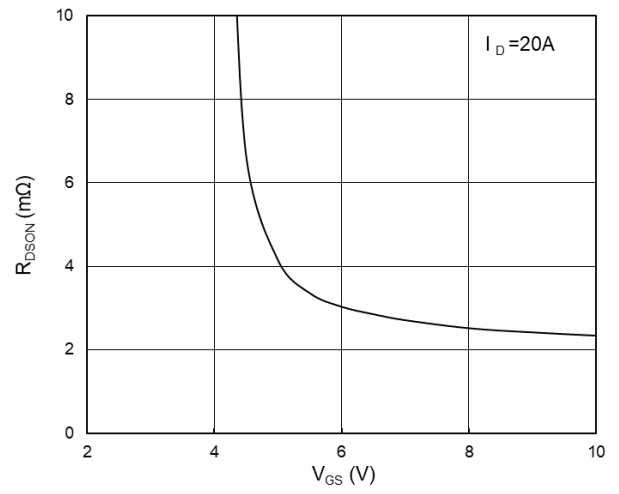

Fig.2 On-Resistance vs G-S Voltage

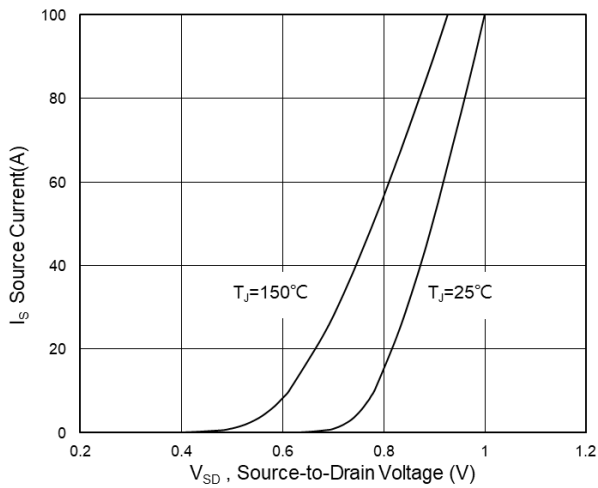

Fig.3 Source Drain Forward Characteristics

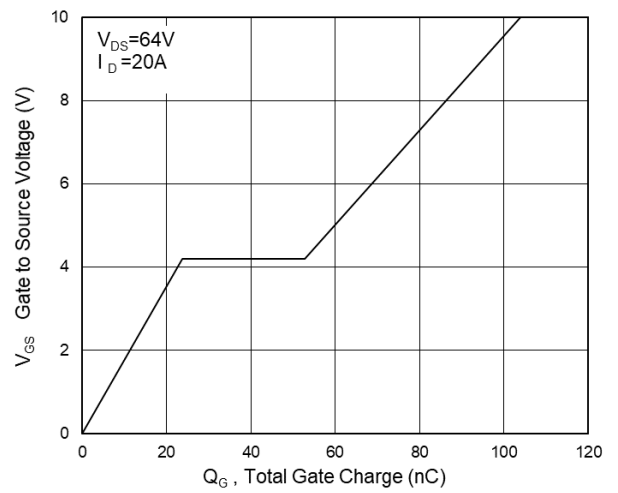

Fig.4 Gate-Charge Characteristics

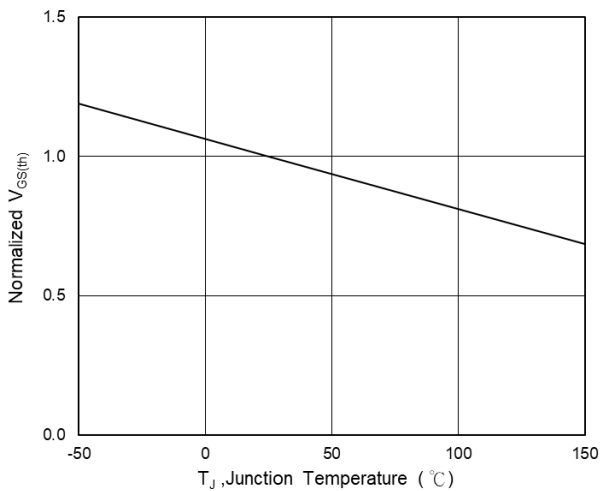

Fig.5 Normalized $V_{GS(th)}$ vs T_J

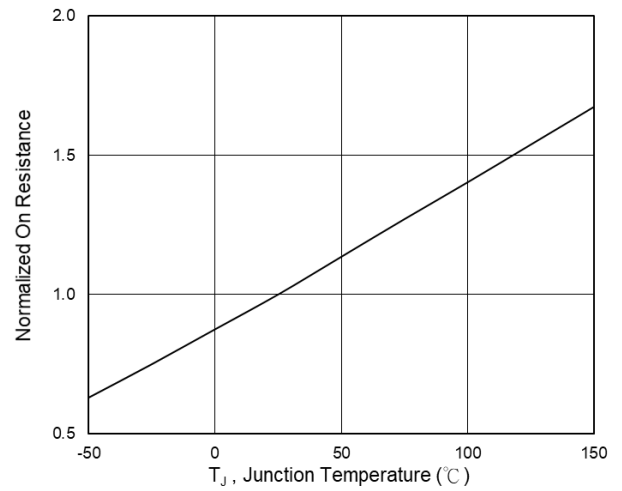

Fig.6 Normalized $R_{DS(on)}$ vs T_J

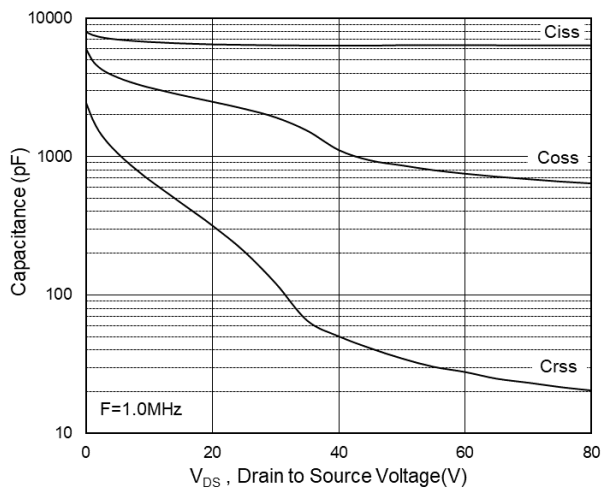

Fig.7 Capacitance

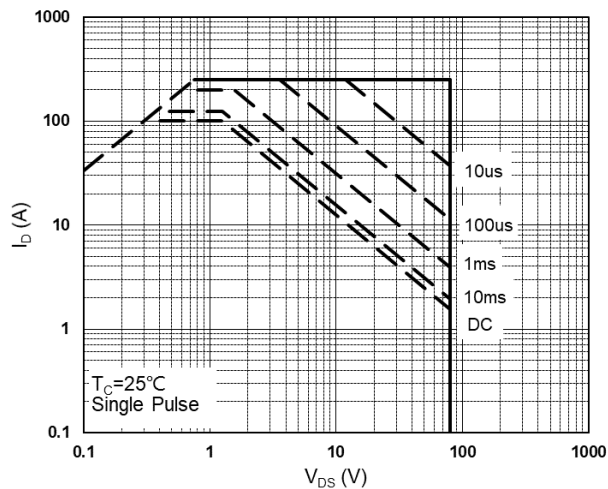

Fig.8 Safe Operating Area

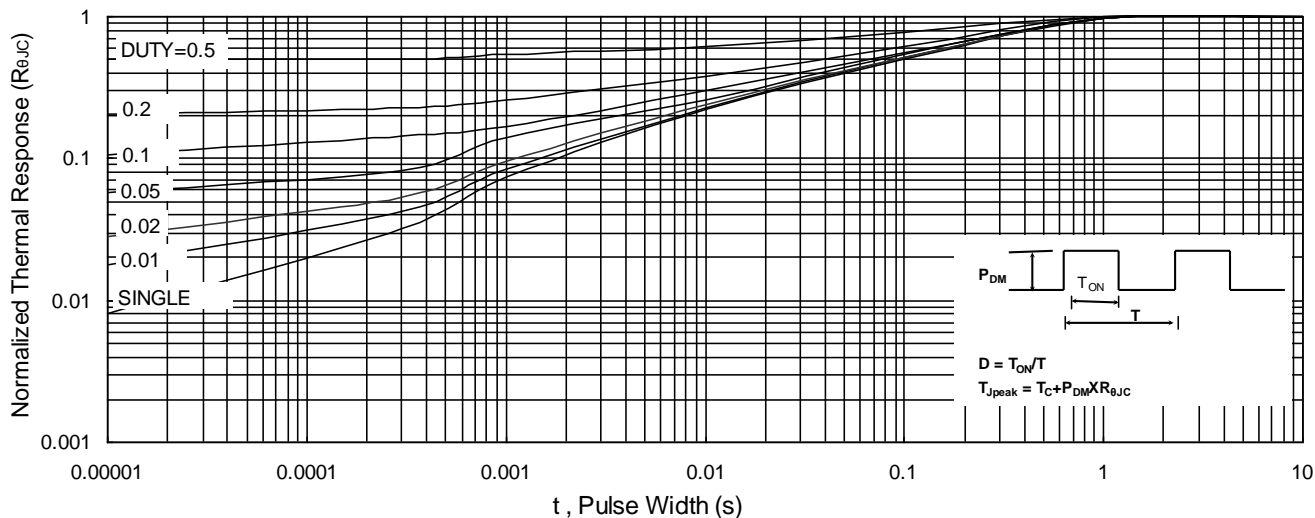

Fig.9 Normalized Maximum Transient Thermal Impedance

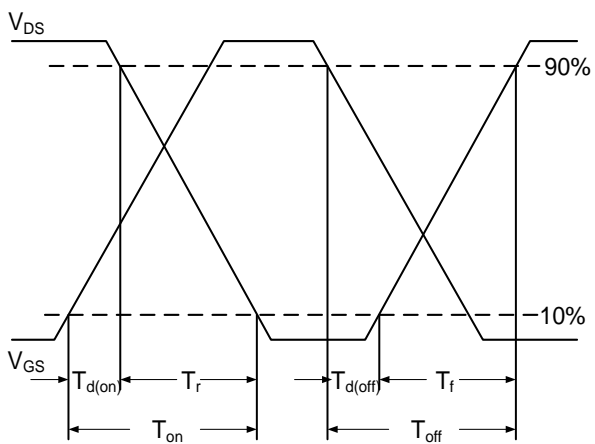

Fig.10 Switching Time Waveform

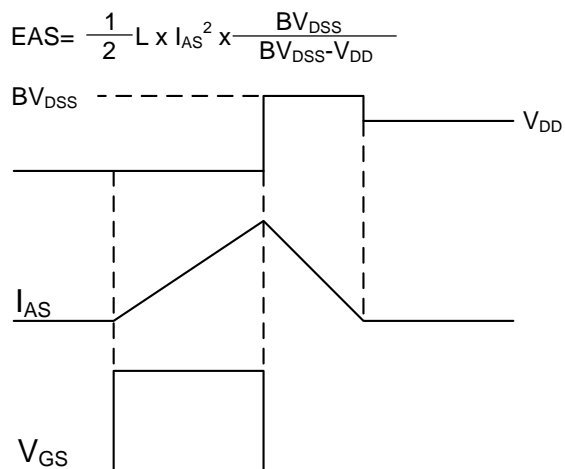
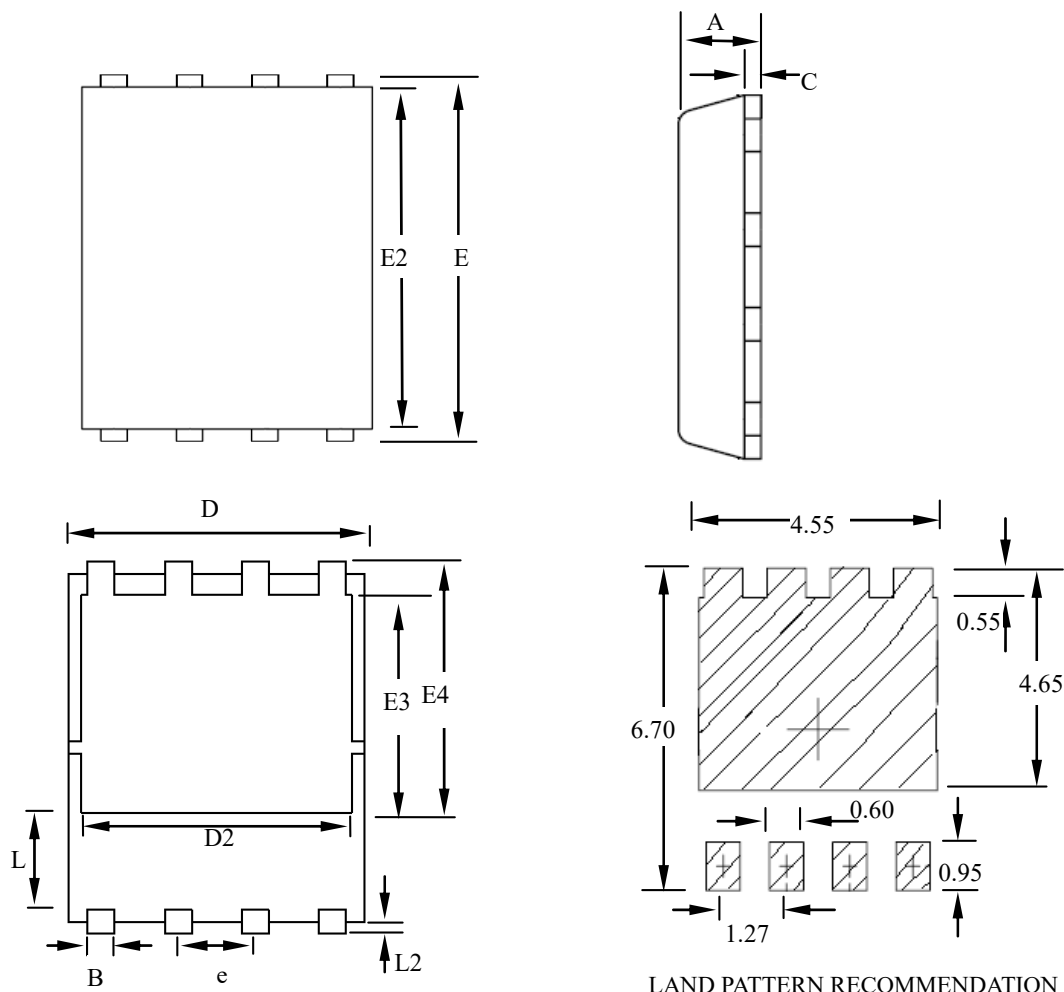

Fig.11 Unclamped Inductive Switching Waveform

JHG8074A

DFN5×6 Outline



SYMBOLS	MILLIMETERS			INCHES		
	MIN	NOM	MAX	MIN	NOM	MAX
A	0.80	--	1.20	0.031	--	0.047
B	0.30	--	0.51	0.012	--	0.020
C	0.15	--	0.35	0.006	--	0.014
D	4.80	--	5.30	0.189	--	0.209
D2	3.61	--	4.35	0.142	--	0.171
E	5.90	--	6.35	0.232	--	0.250
E2	5.42	--	5.90	0.213	--	0.232
E3	3.23	--	3.90	0.127	--	0.154
E4	3.69	--	4.55	0.145	--	0.179
L	0.61	--	1.80	0.024	--	0.071
L2	0.05	--	0.36	0.002	--	0.014
e	--	1.27	--	--	0.050	--

Friendship Reminder

■ JiNan JingHeng (hereinafter referred to as JH) reserves the right to make changes to this document and its products and specifications at anytime without notice.

济南晶恒（以下简称 JH）保留未经通知，变更本文件和与本文件相关的产品及规格的权利。

■ Customers should obtain and confirm the latest product information and specifications before final design, purchase or use.

使用方应在使用、采购本产品之前获取并确认产品信息和规格书的最新版本。

■ JH makes no warranty, representation or guarantee regarding the suitability of its products for any particular purpose, nor does JH assume any liability for application assistance or customer product design.

JH 对其产品用于某特定用途的适用性，既不做任何保证、说明或担保，也不承担任何应用协助或使用方设计的法定责任。

■ JH does not warrant or accept any liability with products which are purchased or used for any unintended or unauthorized application.

JH 不保证或承担任何责任，其产品被采购使用于任何非预期或授权的应用，

■ No license is granted by implication or otherwise under any intellectual property rights of JH.

此规格书属于 JH 的知识产权,没有经过我司授权不得抄袭。

■ JH's products are not authorized for use as critical components in life support devices or systems without express written approval of JH.

没有 JH 的书面授权，JH 的产品不能在生命支撑设备或系统里作为关键零件使用。