

FEATURES

- Total power dissipation: max. 500 mW
- Small plastic package suitable for surface mounted design
- Tolerance approximately $\pm 5\%$
- High temperature soldering guaranteed: 260°C/10 seconds at terminals
- Component in accordance to RoHS 2002/95/EC and WEEE 2002/96/EC

SOD-123FL



SOD-123



MECHANICAL DATA

- Case: SOD-123 plastic case
- Weight: Approx. 0.01 gram

ABSOLUTE MAXIMUM RATINGS(LIMITING VALUES) (TA=25°C)

	<i>Symbols</i>	<i>Value</i>	<i>Units</i>
Zener current see table "Characteristics"			
Power dissipation	P _D	500	mW
Junction temperature	T _J	150	°C
Storage temperature range	T _{STG}	-55 to+150	°C

ELECTRICAL CHARACTERISTICS (TA=25°C)

	<i>Symbols</i>	<i>Min</i>	<i>Typ</i>	<i>Max</i>	<i>Units</i>
Thermal resistance junction to ambient	R _{θJA}			340	°C/W
Thermal resistance junction to Lead	R _{θJL}			150	°C/W
Forward voltage at I _F =10mA	V _F			0.9	V

MM1Z... SILICON PLANAR ZENER DIODES

Type	Marking Code	Zener Voltage range ^{1) 2)}			Dynamic resistance ³⁾			Reverse leakage current	
		V _{ZNOM}	I _{ZT} for V _{ZT}		r _{ZD} and r _{ZJK} at I _{ZK}			I _R	at V _R
		V	mA	V	Ω	Ω	mA	μA	V
MM1Z5221B	A4	2.4	20	2.28...2.52	30	1,200	0.25	100	1
MM1Z5222B	AB	2.5	20	2.38...2.63	30	1,250	0.25	100	1
MM1Z5223B	B4	2.7	20	2.57...2.84	30	1,300	0.25	75	1
MM1Z5224B	AC	2.8	20	2.66...2.94	30	1,400	0.25	75	1
MM1Z5225B	C4	3.0	20	2.85...3.15	29	1,600	0.25	50	1
MM1Z5226B	D4	3.3	20	3.14...3.47	28	1,600	0.25	25	1
MM1Z5227B	E4	3.6	20	3.42...3.78	24	1,700	0.25	15	1
MM1Z5228B	F4	3.9	20	3.71...4.1	23	1,900	0.25	10	1
MM1Z5229B	H4	4.3	20	4.09...4.52	22	2,000	0.25	5	1
MM1Z5230B	J4	4.7	20	4.47...4.94	19	1,900	0.25	5	2
MM1Z5231B	K4	5.1	20	4.85...5.36	17	1,600	0.25	5	2
MM1Z5232B	M4	5.6	20	5.32...5.88	11	1,600	0.25	5	3
MM1Z5233B	AD	6.0	20	5.7...6.3	7	1,600	0.25	5	3.5
MM1Z5234B	N4	6.2	20	5.89...6.51	7	1,000	0.25	5	4
MM1Z5235B	P4	6.8	20	6.46...7.14	5	750	0.25	3	5
MM1Z5236B	R4	7.5	20	7.13...7.88	6	500	0.25	3	6
MM1Z5237B	X4	8.2	20	7.79...8.61	8	500	0.25	3	6.5
MM1Z5238B	AE	8.7	20	8.27...9.14	8	600	0.25	3	6.5
MM1Z5239B	Y4	9.1	20	8.65...9.56	10	600	0.25	3	7
MM1Z5240B	Z4	10	20	9.5...10.5	17	600	0.25	3	8
MM1Z5241B	A5	11	20	10.45...11.55	22	600	0.25	2	8.4
MM1Z5242B	B5	12	20	11.4...12.6	30	600	0.25	1	9.1
MM1Z5243B	C5	13	9.5	12.35...13.65	13	600	0.25	0.5	9.9
MM1Z5245B	D5	15	8.5	14.25...15.75	16	600	0.25	0.1	11
MM1Z5246B	E5	16	7.8	15.2...16.8	17	600	0.25	0.1	12
MM1Z5247B	AH	17	7.4	16.15...17.85	19	600	0.25	0.1	13
MM1Z5248B	F5	18	7	17.1...18.9	21	600	0.25	0.1	14
MM1Z5249B	K9	19	6.6	18.05...19.95	23	600	0.25	0.1	14
MM1Z5250B	H5	20	6.2	19...21	25	600	0.25	0.1	15
MM1Z5251B	J5	22	5.6	20.9...23.1	29	600	0.25	0.1	17
MM1Z5252B	K5	24	5.2	22.8...25.2	33	600	0.25	0.1	18
MM1Z5253B	M9	25	5	23.75...26.25	35	600	0.25	0.1	19
MM1Z5254B	M5	27	4.6	25.65...28.35	41	600	0.25	0.1	21
MM1Z5255B	AJ	28	4.5	26.6...29.4	44	600	0.25	0.1	21
MM1Z5256B	N5	30	4.2	28.5...31.5	49	600	0.25	0.1	23
MM1Z5257B	P5	33	3.8	31.35...34.65	58	700	0.25	0.1	25
MM1Z5258B	R5	36	3.4	34.2...37.8	70	700	0.25	0.1	27
MM1Z5259B	X5	39	3.2	37.05...40.95	80	800	0.25	0.1	30
MM1Z5260B	Y5	43	3	40.85...45.15	93	900	0.25	0.1	33
MM1Z5261B	Z5	47	2.7	44.65...49.35	105	1,000	0.25	0.1	36
MM1Z5262B	A6	51	2.5	48.45...53.55	125	1,100	0.25	0.1	39
MM1Z5263B	B6	56	2.2	53.2...58.8	150	1,300	0.25	0.1	43
MM1Z5264B	AK	60	2.1	57...63	170	1,400	0.25	0.1	46
MM1Z5265B	C6	62	2	58.9...65.1	185	1,400	0.25	0.1	47
MM1Z5266B	D6	68	1.8	64.6...71.4	230	1,600	0.25	0.1	52
MM1Z5267B	E6	75	1.7	71.25...78.75	270	1,700	0.25	0.1	56
MM1Z5268B	F6	82	1.5	77.9...86.1	330	2,000	0.25	0.1	62

1) V_Z is tested with pulses t_p=20ms.

2) Nominal Zener voltage is measured with device junction in thermal equilibrium at T_L=30°C ± 1°C.

3) Z_T and Z_K are measured by dividing the AC voltage drop across the device by the AC current applied. The specified limits are for I_{Z(AC)}=0.1 I_{Z(OC)} with AC frequency = 1 kHz.

MM1Z... SILICON PLANAR ZENER DIODES

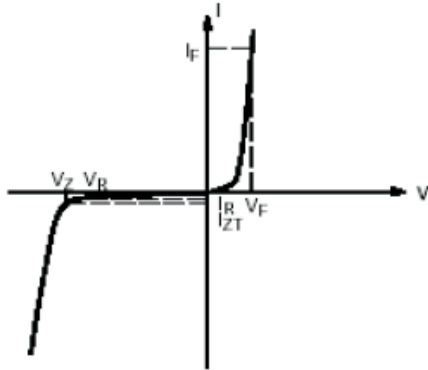

Figure 1. Zener Voltage Regulator

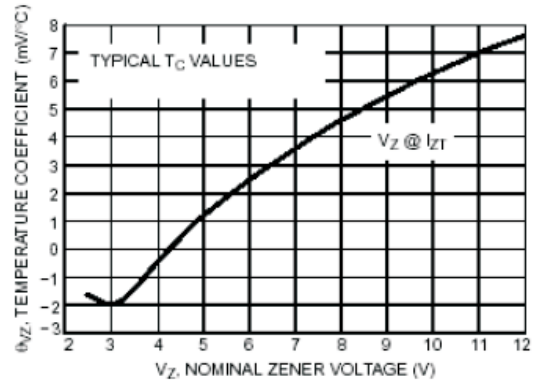

Figure 2. Temperature Coefficients (Temperature Range -55°C to +150°C)

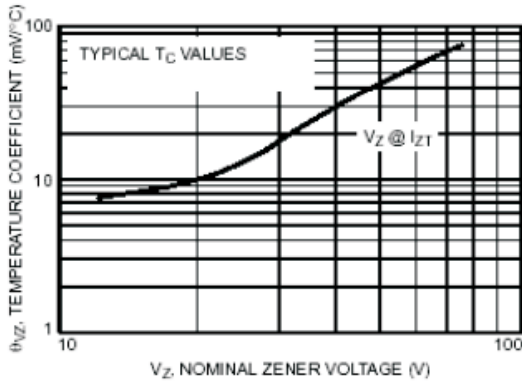

Figure 3. Temperature Coefficients (Temperature Range -55°C to +150°C)

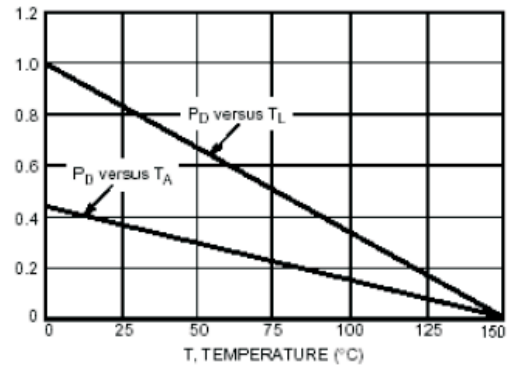

Figure 4. Steady State Power Derating

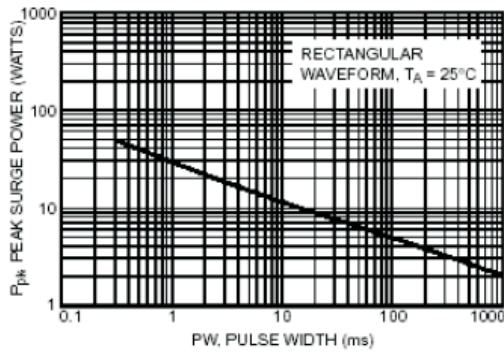

Figure 5. Maximum Nonrepetitive Surge Power

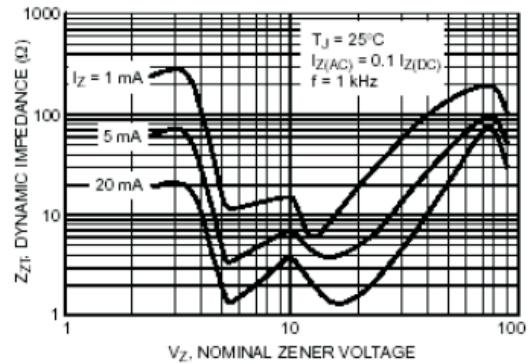

Figure 6. Effect of Zener Voltage on Zener Impedance

MM1Z... SILICON PLANAR ZENER DIODES

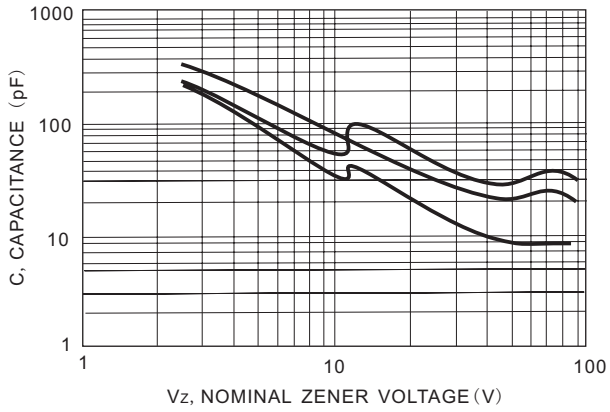

Figure 7. Typical Capacitance

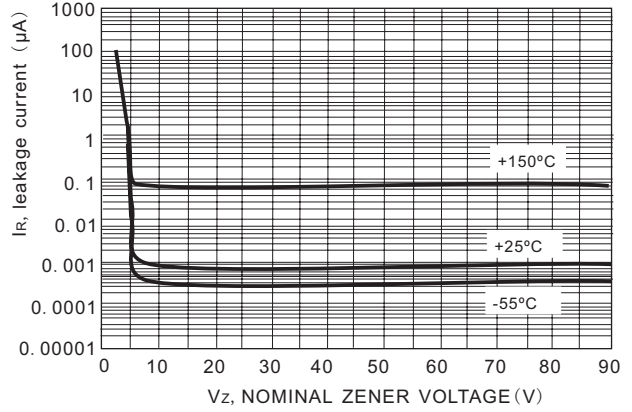

Figure 8. Typical Leakage Current

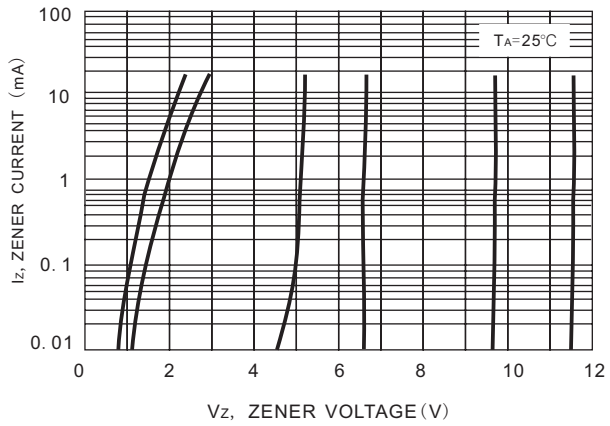

Figure 9. Zener Voltage versus Zener Current (Vz Up to 12V)

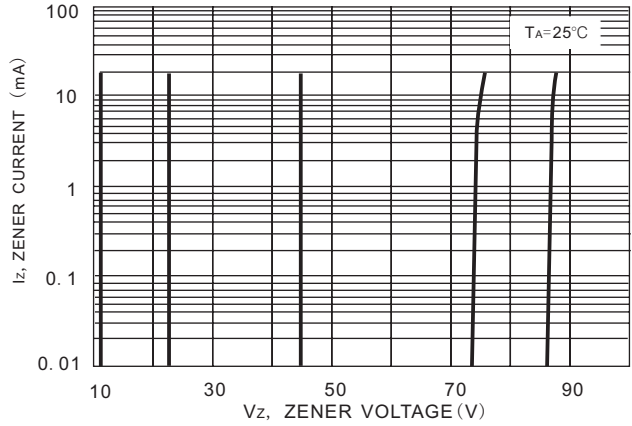
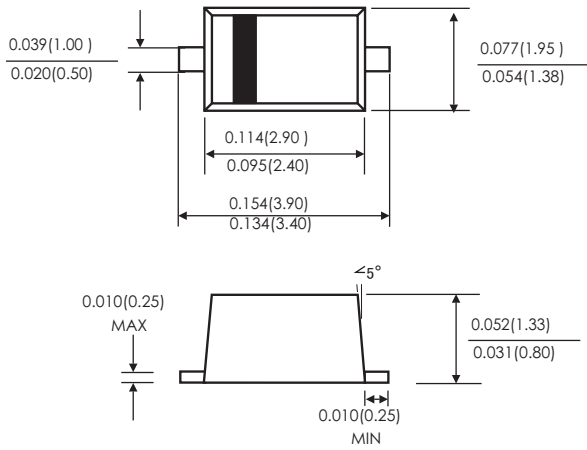

Figure 10. Zener Voltage versus Zener Current

MM1Z... SILICON PLANAR ZENER DIODES

SOD-123FL



Dimensions in inches and (millimeters)

SOD-123

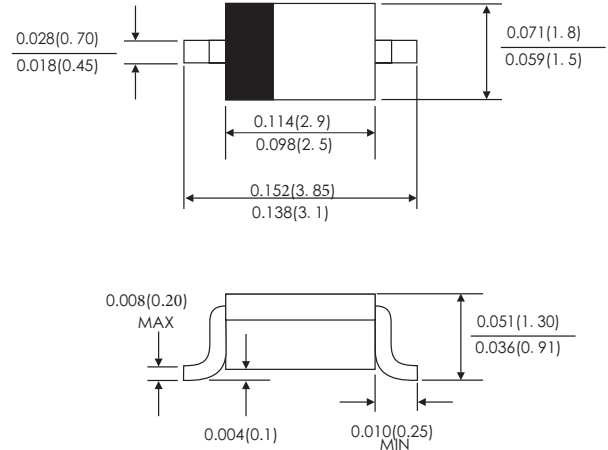

Dimensions in inches and (millimeters)