

Features

- 100% EAS Guaranteed
- Green Device Available
- Super Low Gate Charge
- Excellent CdV/dt effect decline
- Advanced high cell density Trench technology

Description

The JHS3303 is the high cell density trenched P-ch MOSFETs, which provide excellent R_{DS(on)} and gate charge for most of the synchronous buck converter applications.

The JHS3303 meet the RoHS and Green Product requirement, 100% EAS guaranteed with full function reliability approved.

Product Summary

BVDSS	R _{DS(on)}	I _D
-30V	25mΩ	-6.5A

SOP-8 Pin Configuration

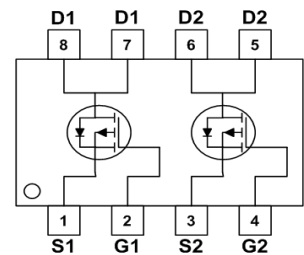
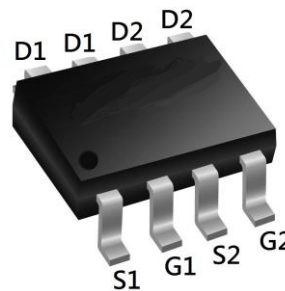

Absolute Maximum Ratings

Symbol	Parameter	Rating	Units
V _{DS}	Drain-Source Voltage	-30	V
V _{GS}	Gate-Source Voltage	±20	V
I _D @T _A =25°C	Continuous Drain Current, -V _{GS} @ -10V ¹	-6.5	A
I _D @T _A =70°C	Continuous Drain Current, -V _{GS} @ -10V ¹	-5.2	A
I _{DM}	Pulsed Drain Current ²	-26	A
EAS	Single Pulse Avalanche Energy ³	72.2	mJ
I _{AS}	Avalanche Current	-38	A
P _D @T _A =25°C	Total Power Dissipation ⁴	1.5	W
T _{STG}	Storage Temperature Range	-55 to 150	°C
T _J	Operating Junction Temperature Range	-55 to 150	°C

Thermal Data

Symbol	Parameter	Typ.	Max.	Unit
R _{θJA}	Thermal Resistance Junction-Ambient ¹	---	85	°C/W
R _{θJC}	Thermal Resistance Junction-Case ¹	---	25	°C/W

Electrical Characteristics (T_J=25 °C, unless otherwise noted)

Symbol	Parameter	Conditions	Min.	Typ.	Max.	Unit
BV _{DSS}	Drain-Source Breakdown Voltage	V _{GS} =0V, I _D =-250uA	-30	---	---	V
ΔBV _{DSS} /ΔT _J	BV _{DSS} Temperature Coefficient	Reference to 25°C, I _D =-1mA	---	-0.022	---	V/°C
R _{DS(ON)}	Static Drain-Source On-Resistance ²	V _{GS} =-10V, I _D =-6A	---	---	25	mΩ
		V _{GS} =-4.5V, I _D =-4A	---	---	42	
V _{GS(th)}	Gate Threshold Voltage	V _{GS} =V _{DS} , I _D =-250uA	-1.0	---	-2.5	V
ΔV _{GS(th)}	V _{GS(th)} Temperature Coefficient		---	4.6	---	mV/°C
I _{DSS}	Drain-Source Leakage Current	V _{DS} =-24V, V _{GS} =0V, T _J =25°C	---	---	-1	uA
		V _{DS} =-24V, V _{GS} =0V, T _J =55°C	---	---	-5	
I _{GSS}	Gate-Source Leakage Current	V _{GS} =±20V, V _{DS} =0V	---	---	±100	nA
g _{fs}	Forward Transconductance	V _{DS} =-5V, I _D =-6A	---	17	---	S
R _g	Gate Resistance	V _{DS} =0V, V _{GS} =0V, f=1MHz	---	13	---	Ω
Q _g	Total Gate Charge (-4.5V)	V _{DS} =-15V, V _{GS} =-4.5V, I _D =-6A	---	12.6	---	nC
Q _{gs}	Gate-Source Charge		---	4.8	---	
Q _{gd}	Gate-Drain Charge		---	4.8	---	
T _{d(on)}	Turn-On Delay Time	V _{DD} =-15V, V _{GS} =-10V, R _G =3.3Ω, I _D =-6A	---	4.6	---	ns
T _r	Rise Time		---	14.8	---	
T _{d(off)}	Turn-Off Delay Time		---	41	---	
T _f	Fall Time		---	19.6	---	
C _{iss}	Input Capacitance	V _{DS} =-15V, V _{GS} =0V, f=1MHz	---	1345	---	pF
C _{oss}	Output Capacitance		---	194	---	
C _{rss}	Reverse Transfer Capacitance		---	158	---	

Diode Characteristics

I _S	Continuous Source Current ¹	V _G =V _D =0V, Force Current	---	---	-6.5	A
I _{SM}	Pulsed Source Current ²		---	---	-26	A
V _{SD}	Diode Forward Voltage ²	V _{GS} =0V, I _S =-1A, T _J =25°C	---	---	-1.2	V
t _{rr}	Reverse Recovery Time	I _F =-6A, dI/dt=100A/μs, T _J =25°C	---	16.3	---	nS
Q _{rr}	Reverse Recovery Charge		---	5.9	---	nC

Note :

- 1.The data tested by surface mounted on a 1 inch² FR-4 board with 2OZ copper.
- 2.The data tested by pulsed, pulse width ≤ 300us, duty cycle ≤ 2%
- 3.The EAS data shows Max. rating. The test condition is V_{DD}=-25V, V_{GS}=-10V, L=0.1mH, I_{AS}=-38A
- 4.The power dissipation is limited by 150°C junction temperature

Typical Characteristics

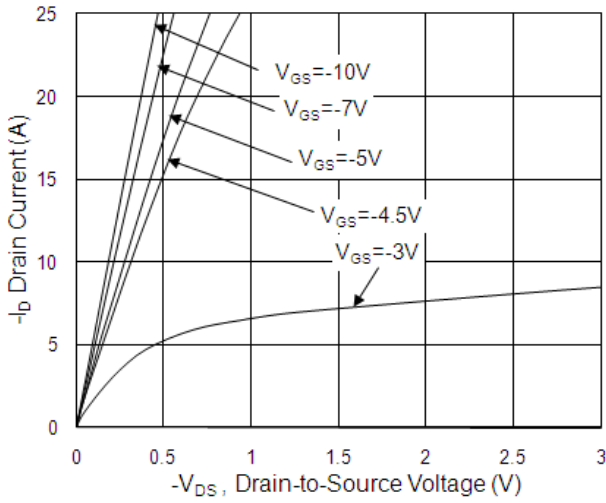

Fig.1 Typical Output Characteristics

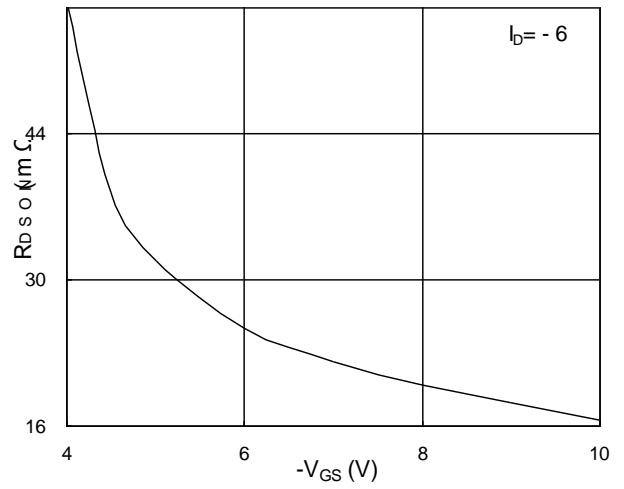

Fig.2 On-Resistance v.s Gate-Source

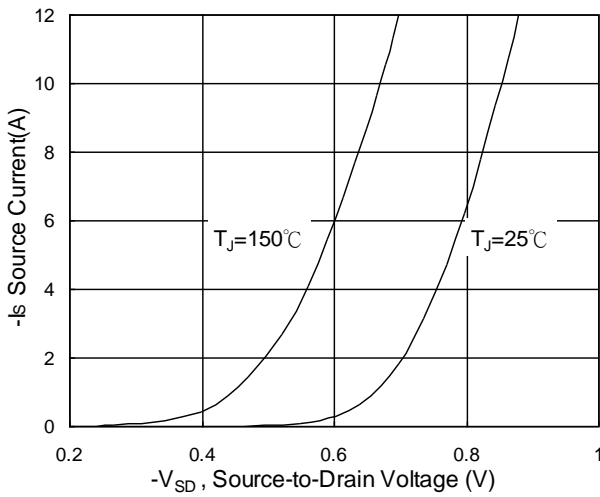

Fig.3 Forward Characteristics of Reverse

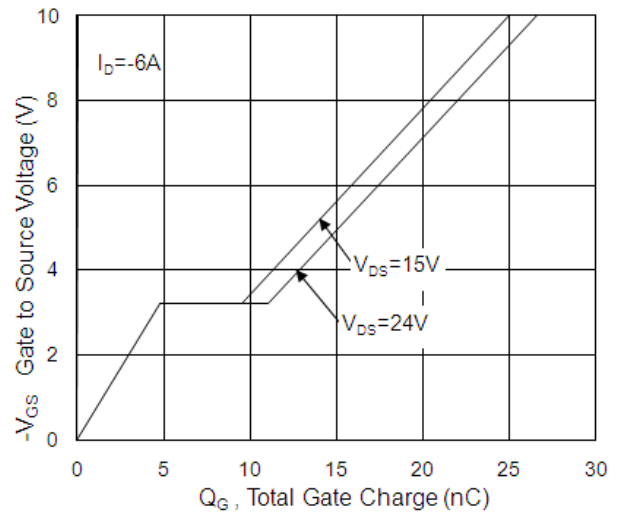

Fig.4 Gate-Charge Characteristics

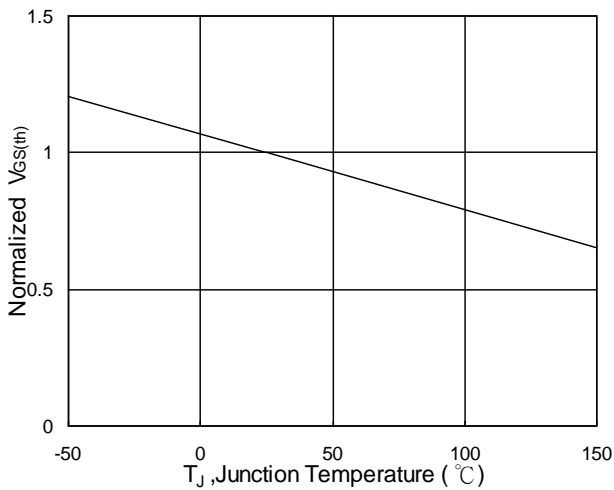

Fig.5 Normalized $V_{GS(th)}$ vs. T_J

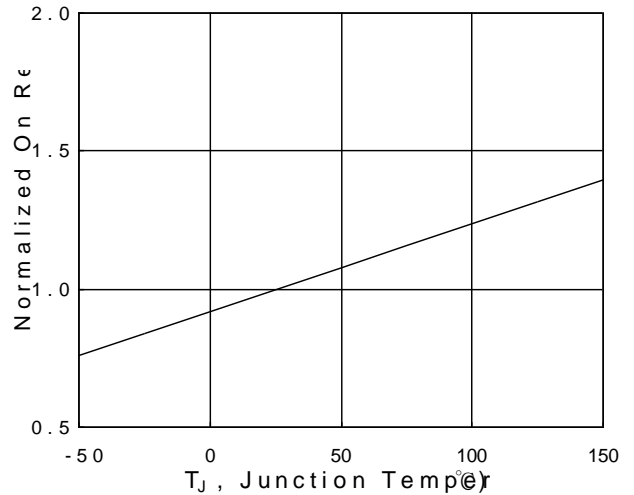

Fig.6 Normalized $R_{DS(on)}$ vs. T_J

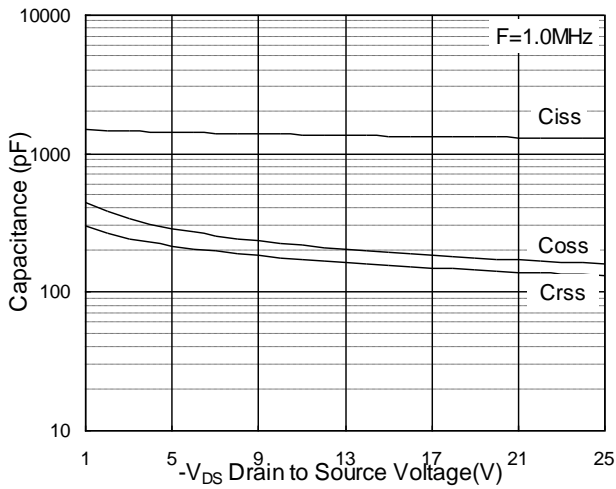

Fig.7 Capacitance

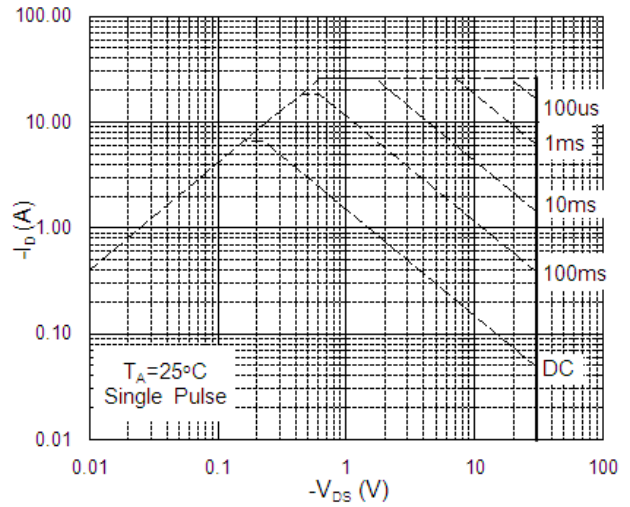

Fig.8 Safe Operating Area

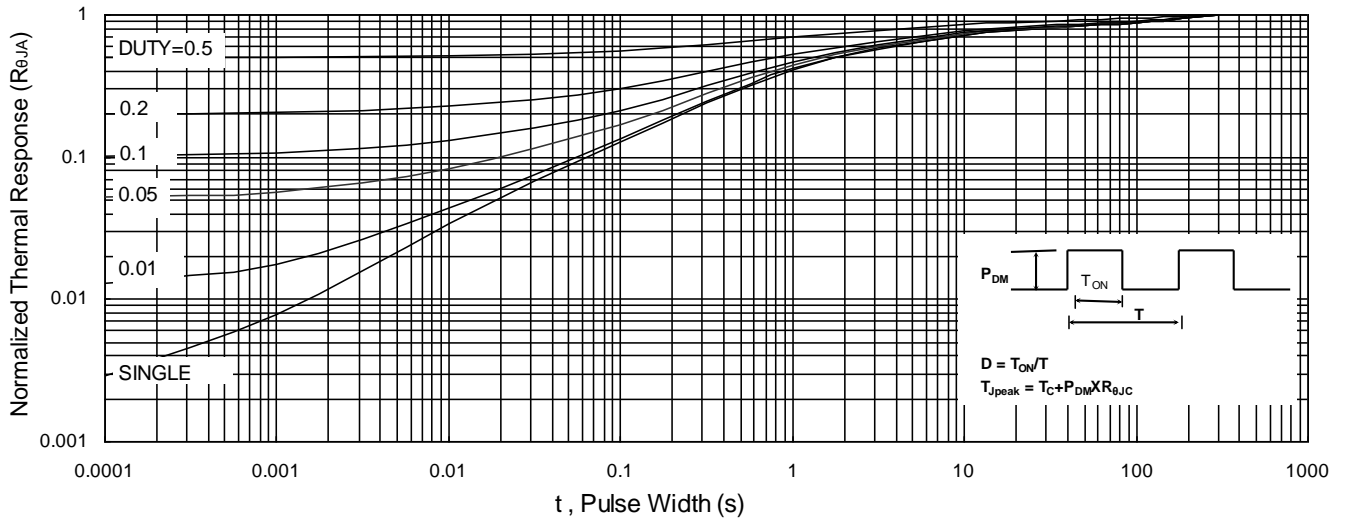

Fig.9 Normalized Maximum Transient Thermal Impedance

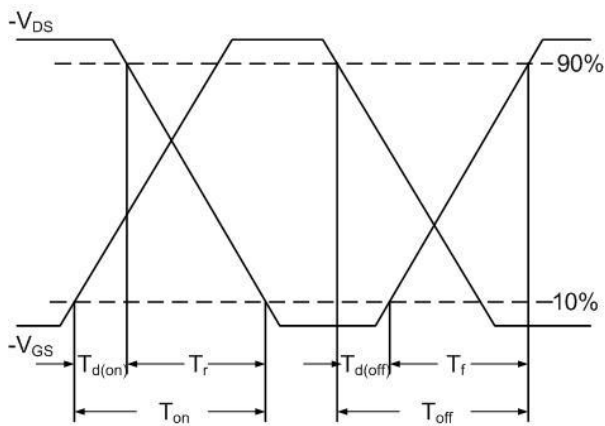

Fig.10 Switching Time Waveform

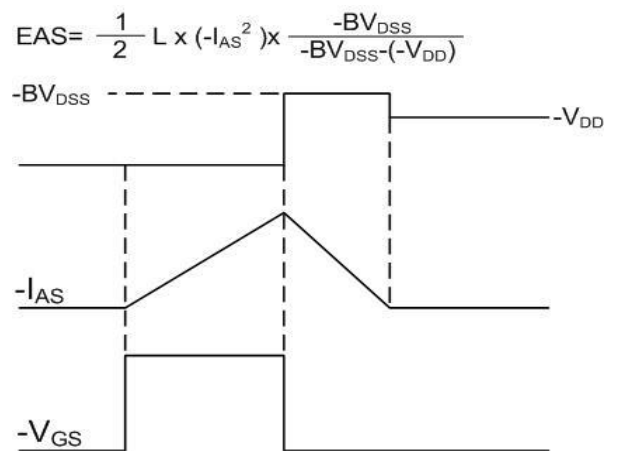
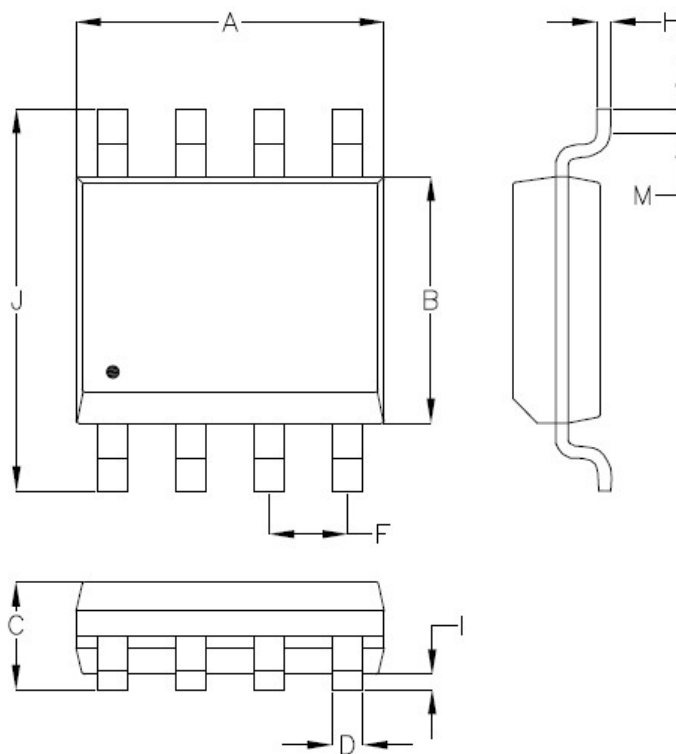

Fig.11 Unclamped Inductive Switching Waveform

SOP-8L Package Outline



SYMBOLS	MILLIMETERS		INCHES	
	MIN	MAX	MIN	MAX
A	4.700	5.150	0.185	0.203
B	3.700	4.100	0.146	0.161
C	1.23	1.753	0.048	0.069
D	0.310	0.510	0.012	0.020
F	1.070	1.470	0.042	0.058
H	0.160	0.254	0.006	0.010
I	0.050	0.254	0.002	0.010
J	5.750	6.250	0.226	0.246
M	0.400	1.270	0.016	0.050

Friendship Reminder

■ JiNan JingHeng (hereinafter referred to as JH) reserves the right to make changes to this document and its products and specifications at anytime without notice.

济南晶恒（以下简称 JH）保留未经通知，变更本文件和与本文件相关的产品及规格的权利。

■ Customers should obtain and confirm the latest product information and specifications before final design, purchase or use.

使用方应在使用、采购本产品之前获取并确认产品信息和规格书的最新版本。

■ JH makes no warranty, representation or guarantee regarding the suitability of its products for any particular purpose, nor does JH assume any liability for application assistance or customer product design.

JH 对其产品用于某特定用途的适用性，既不做任何保证、说明或担保，也不承担任何应用协助或使用方设计的法定责任。

■ JH does not warrant or accept any liability with products which are purchased or used for any unintended or unauthorized application.

JH 不保证或承担任何责任，其产品被采购使用于任何非预期或授权的应用，

■ No license is granted by implication or otherwise under any intellectual property rights of JH.

此规格书属于 JH 的知识产权,没有经过我司授权不得抄袭。

■ JH's products are not authorized for use as critical components in life support devices or systems without express written approval of JH.

没有 JH 的书面授权，JH 的产品不能在生命支撑设备或系统里作为关键零件使用。