

FEATURES

- Plastic package has Underwriters Laboratory Flammability Classification 94V-0
- Fast switching for high efficiency
- Low forward voltage drop
- Single rectifier construction
- High surge capability
- For use in low voltage ,high frequency inverters, free wheeling ,and polarity protection applications
- High temperature soldering guaranteed:260°C/10 seconds, 0.25"(6.35mm)from case
- Component in accordance to RoHS 2011/65/EU

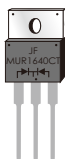

TO-220AB

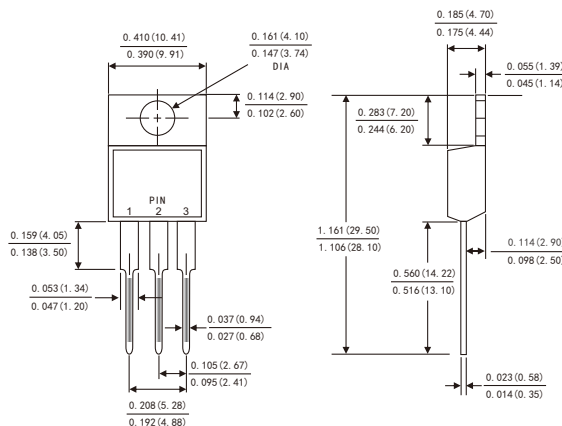

Dimensions in inches and (millimeters)

MECHANICAL DATA

- Case: JEDEC TO-220AC molded plastic body
- Terminals: Lead solderable per MIL-STD-750,method 2026
- Polarity: As marked
- Mounting Position: Any
- Weight: 0.08ounce, 2.24 gram

MAXIMUM RATINGS AND ELECTRICAL CHARACTERISTICS

(Ratings at 25°C ambient temperature unless otherwise specified ,Single phase ,half wave ,resistive or inductive load. For capacitive load,derate by 20%.)

Parameters	Symbols	MUR 1620CT	MUR 1640CT	MUR 1660CT	Units
Maximum repetitive peak reverse voltage	VRRM	200	400	600	Volts
Maximum RMS voltage	VRMS	140	280	420	Volts
Maximum DC blocking voltage	VDC	200	400	600	Volts
Maximum average forward rectified current(see Fig.1)	Per leg	8.0			Amps
	Total device	16.0			
Peak forward surge current 8.3ms single half sine-wave superimposed on rated load (JEDEC method)	IFSM	150			Amps
Maximum instantaneous forward voltage at 8.0 A per leg(Note 1)	VF	0.975	1.3	1.5	Volts
Maximum instantaneous reverse current at rated DC blocking voltage(Note 1)	T _a =25°C	5			µA
	T _a =125°C	50			
Maximum Reverse Recovery Time (Note 2)	T _{rr}	35			ns
Typical thermal resistance (Note 3)	R _{θJC}	2.5			°C/W
Operating junction temperature range	T _J	-55 to+175			°C
Storage temperature range	T _{STG}	-55 to+175			°C

- Notes:**
1. Pulse test: 300µs pulse width,1% duty cycle
 2. Reverse recovery test conditions I_F=0.5A,I_R=1.0A, I_{rr}=0.25A
 3. Thermal resistance from junction to case

RATINGS AND CHARACTERISTIC CURVES MUR1620CT THRU MUR1660CT

FIG.1-FORWARD CURRENT DERATING CURVE

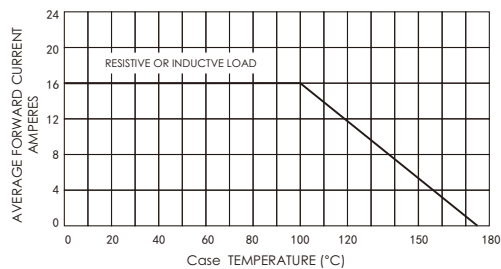

FIG.2-MAXIMUM NON-REPETITIVE PEAK FORWARD SURGE CURRENT

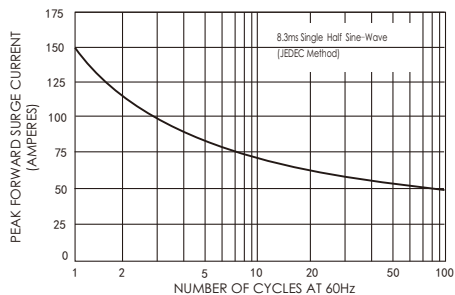

FIG.3-TYPICAL INSTANTANEOUS FORWARD CHARACTERISTICS

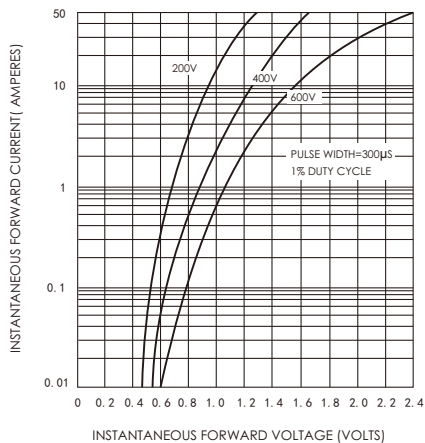

FIG.4-TYPICAL REVERSE CHARACTERISTICS

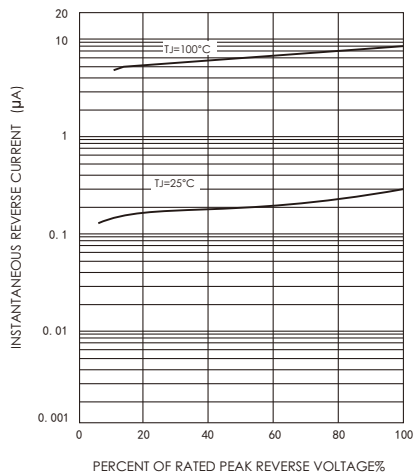

FIG.5-TYPICAL JUNCTION CAPACITANCE

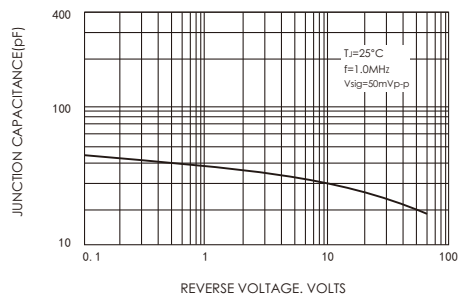

FIG.6-TYPICAL TRANSIENT THERMAL IMPEDANCE

