

FEATURES

- Plastic package has Underwriters Laboratory Flammability Classification 94V-0
- Metal silicon junction ,majority carrier conduction
- Guard ring for overvoltage protection
- Low power loss ,high efficiency
- High current capability ,low forward voltage drop
- High surge capability
- Very low profile-typical height of 1.1mm
- Ideal for automated placement
- High temperature soldering guaranteed:260°C/10 seconds at terminals
- Component in accordance to RoHS 2015/863/EU

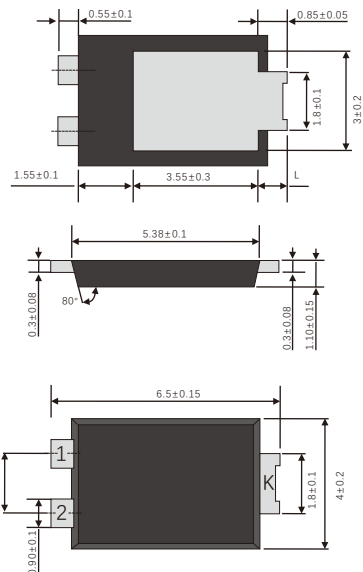

TO-277



MECHANICAL DATA

- Case: TO-277 molded plastic body
- Terminals: Plated axial leads, solderable per MIL-STD-750,method 2026
- Mounting Position: Any
- Weight: 0.092 grams(approx)

TYPICAL APPLICATIONS

For use in low voltage ,high frequency inverters ,DC/DC converters, free wheeling ,and polarity protection applications

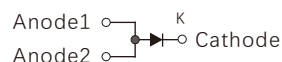

Dimensions in inches and (millimeters)

MAXIMUM RATINGS

(Ratings at 25°C ambient temperature unless otherwise specified)

Parameter	Symbol	Value	Unit
Maximum repetitive peak reverse voltage	V_{RRM}	200	V
Maximum average forward rectified current	$I_{F(AV)}$	10.0	A
Peak forward surge current 8.3ms single half sine-wave superimposed on rated load (JEDEC method at rated TL)	I_{FSM}	180	A
Operating junction temperature range	T_j	-55 to+150	°C
Storage temperature range	T_{stg}	-55 to+150	°C

ELECTRICAL CHARACTERISTICS (T_A=25°C Unless otherwise noted)

Parameter	Test Conditions		Symbol	Typ.	Max.	Unit
Instaneous forward voltage	I _F =10.0A	T _J =25°C	V _F ¹⁾	0.81	0.90	V
		T _J =100°C		0.72	-	
		T _J =125°C		0.68	-	
	I _F =2.0A	T _J =25°C		0.69	-	
		T _J =100°C		0.58	-	
		T _J =125°C		0.54	-	
Reverse current	V _R =200V	T _J =25°C	I _R ²⁾	-	5.0	μA
		T _J =100°C		-	0.5	mA
		T _J =125°C		-	1.5	
Typical junction capacitance	4V,1MHz		C _J	170		pF

Notes: 1.Pulse test: 300 μs pulse width,1% duty cycle

2.Pulse test: pulse width≤40ms

THERMAL CHARACTERISTICS

Parameter	Symbol	TO-277	Unit
Typical thermal resistance ³⁾	R _{θJA}	60.0	°C/W
	R _{θJL}	3.0	

3 Units mounted on recommended PCB 1 oz. Pad layout

AVAILABALE PACK INFORMATION

Product code	Pack	Carton Size L×W×H(mm)	Inner Box Size L×W×H(mm)	Reel diameter (mm)	Inner Box Number	Reel Number Per A Inner Box	Part Number Per A Reel(K)	Quantity(carton) (K)
Sp10200- TO-277	Reel	370×370×360	338×338×39	φ330	7	2	5	70

FIG.1-FORWARD CURRENT DERATING CURVE

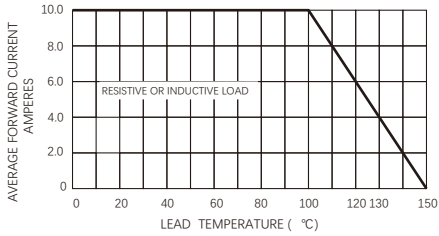

FIG.2-MAXIMUM NON-REPETITIVE PEAK FORWARD SURGE CURRENT

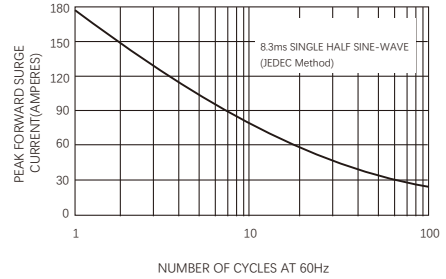

FIG.3-TYPICAL INSTANTANEOUS FORWARD CHARACTERISTICS

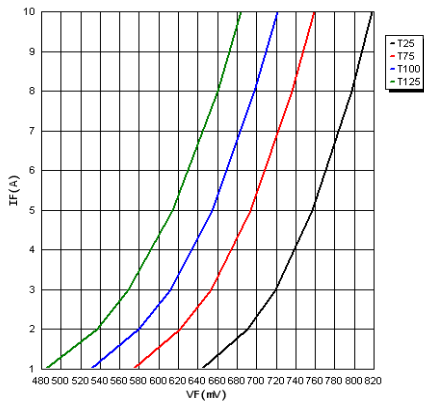

FIG.4-TYPICAL REVERSE CHARACTERISTICS

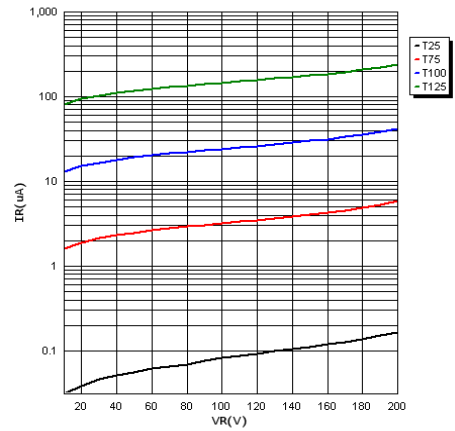
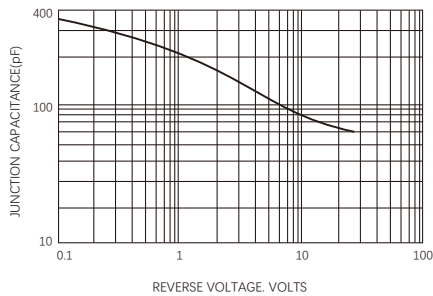

FIG.5-TYPICAL JUNCTION CAPACITANCE



Friendship Reminder

- JiNan JingHeng (hereinafter referred to as JH) reserves the right to make changes to this document and its products and specifications at anytime without notice.
- Customers should obtain and confirm the latest product information and specifications before final design, purchase or use.
- JH makes no warranty, representation or guarantee regarding the suitability of its products for any particular purpose, nor does JH assume any liability for application assistance or customer product design.
- JH does not warrant or accept any liability with products which are purchased or used for any unintended or unauthorized application.
- No license is granted by implication or otherwise under any intellectual property rights of JH.
- JH's products are not authorized for use as critical components in life support devices or systems without express written approval of JH.