

Features

- The plastic package has Underwrites Laboratory Flammability Classification 94V-0
- Glass passivation chip junction
- High surge current capability
- Low leakage current
- Low forward voltage drop
- High temperature soldering guaranteed: 260°C/10 seconds at terminals
- Component in accordance to RoHS 2015/863/EU



SMC(DO-214AB)

Mechanical Data

- Case: SMC molded plastic body
- Terminals: Plated axial lead, solderable per MIL-STD-750,method 2026
- Polarity: Color band denotes cathode end
- Mounting Position: Any



Cathode \leftarrow \rightarrow Anode

Applications

- For use in general purpose rectification of power supply,inverters, converters,and freewheeling diodes application.

Maximum Ratings And Electrical Characteristics

(Ratings at 25°C ambient temperature unless otherwise specified ,Single phase ,half wave 60Hz,,resistive or inductive load. For capacitive load, derate by 20%.)

Parameters	Symbols	Value	Unis
Maximum recurrent peak reverse voltage	V_{RRM}	1000	Volts
Maximum RMS voltage	V_{RMS}	700	Volts
Maximum DC blocking voltage	V_{DC}	1000	Volts
Maximum average forward rectified current	$I_{F(AV)}$	10.0	Amps
Peak forward surge current (8.3ms half sine-wave superimposed on rated load (JEDEC method)	I_{FSM}	240	Amps
Maximum instantaneous forward voltage at 10.0 A	V_f	1.10	Volts
Maximum reverse current at rated DC blocking voltage	I_R	$T_A=25^{\circ}C$	5.0
		$T_A=125^{\circ}C$	100.0
Typical junction capacitance (Note 1)	C_j	60	pF
Typical Thermal Resistance(Note2)	$R_{\theta JA}$	47	°C/W
	$R_{\theta JL}$	10	
Operating and Storage temperature range	T_j, T_{STG}	-55 to +150	°C

Note 1.Measured at 1MHz and applied reverse voltage of 4.0V DC.

2.P.C.B. mounted with 0.60" x 0.60" (16.0 mm x 16.0 mm) copper pad areas

Fig.1-FORWARD CURRENT DERATING CURVE

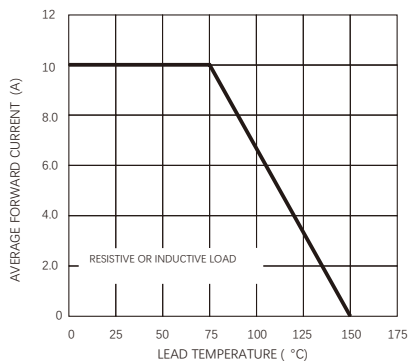

Fig.2-Typical Instantaneous Forward Characteristics

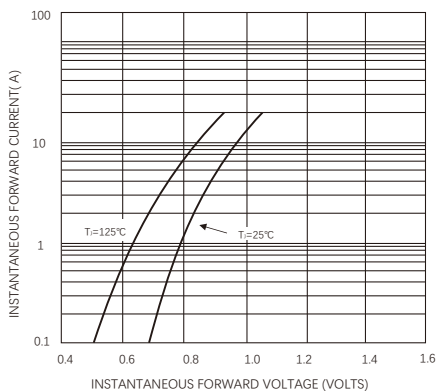

Fig.3-Maximum Non-repetitive Peak Forward Surge Current

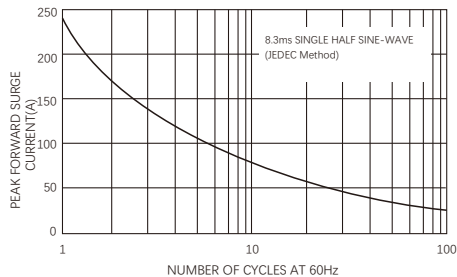

Fig.4-Typical Reverse Characteristics

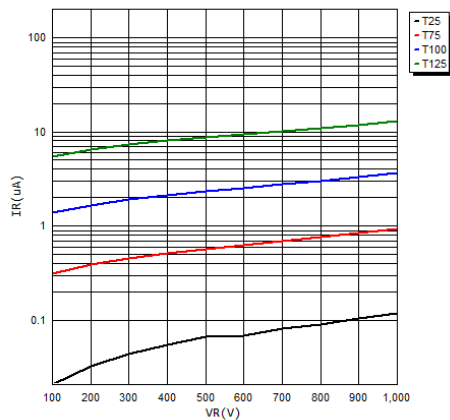
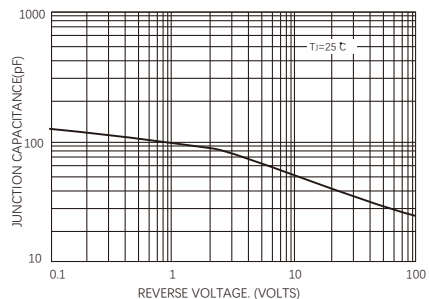

Fig.5-typical Junction Capacitance



AVAILABLE PACK INFORMATION

Product code	Pack	Reel Size (mm)	Quantity (pcs/reel)	Box Size L×W×H (mm)	Quantity (reel/box)	Carton Size L×W×H (mm)	Quantity (box/carton)	Quantity (carton) (K)
S10MC-SMC	T/R	Φ330	3000	338×338×39	2	370×370×360	8	48

PACKAGE OUTLINE DIMENSIONS

SMC(DO-214AB)

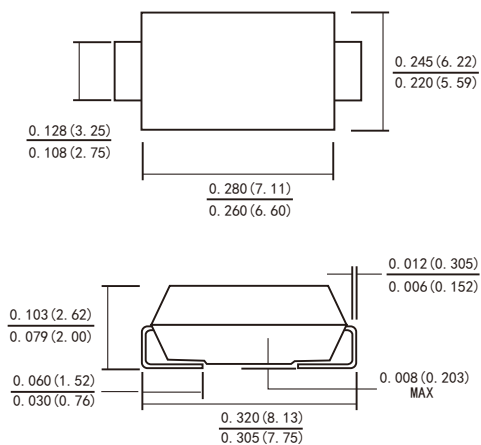

Dimensions in inches and (millimeters)

Suggested PAD Layout

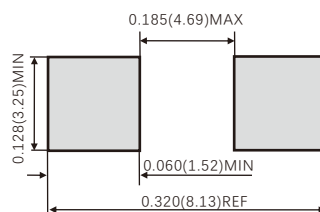

Friendship Reminder

- JiNan JingHeng (hereinafter referred to as JH) reserves the right to make changes to this document and its products and specifications at anytime without notice.
- Customers should obtain and confirm the latest product information and specifications before final design, purchase or use.
- JH makes no warranty, representation or guarantee regarding the suitability of its products for any particular purpose, nor does JH assume any liability for application assistance or customer product design.
- JH does not warrant or accept any liability with products which are purchased or used for any unintended or unauthorized application.
- No license is granted by implication or otherwise under any intellectual property rights of JH.
- JH's products are not authorized for use as critical components in life support devices or systems without express written approval of JH.