

FEATURES

- Plastic package has Underwriters Laboratory Flammability Classification 94V-0
- Glass passivated Chip
- Low VF, Low power loss
- Flexible solution for reliable AC power rectification
- High surge capability
- High temperature soldering guaranteed: 260°C/10s at terminals
- Component in accordance to RoHS 2015/863/EU

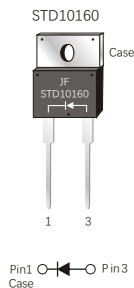

TO-220AC



MECHANICAL DATA

- Case: JEDEC TO-220AC
- Molding compound meets UL94V-0 flammability rating
- Terminals: Lead solderable per J-STD-002 and JESD22-B102
- Polarity: As marked

TYPICAL APPLICATIONS

- Input Rectification
- Bypass Diode
- Polarity Reverse Protection
- EV / HEV Battery Chargers

MAXIMUM RATINGS AND ELECTRICAL CHARACTERISTICS

(Ratings at 25°C ambient temperature unless otherwise specified)

Parameters	Symbols	Value	Units
Maximum repetitive peak reverse voltage	V _{RRM}	1600	V
Maximum RMS voltage	V _{RMS}	1130	V
Maximum DC blocking voltage	V _{DC}	1600	V
Maximum average forward rectified current(D=0.5 Rectangular wave)	I _{F(AV)}	10.0	A
Peak forward surge current 8.3ms single half sine-wave superimposed on rated load, (JEDEC method Total device)	I _{FSM}	120	A
Maximum Forward voltage at 10A(Note 1)	V _F	1.30	V
Maximum instantaneous reverse current at rated DC blocking voltage(Note 1)	T _J =25°C	5.0	uA
	T _J =125°C	250	uA
Typical thermal resistance (Note 2)	R _{θJC}	0.95	°C/W
Operating junction temperature range	T _J	- 55 to+150	°C
Storage temperature range	T _{STG}	- 55 to+150	°C

Notes: 1.Pulse test: 300 us pulse width,1% duty cycle
2.When mounted on 1" square (650 mm²) PCB of FR-4

FIG.1-FORWARD CURRENT DERATING CURVE

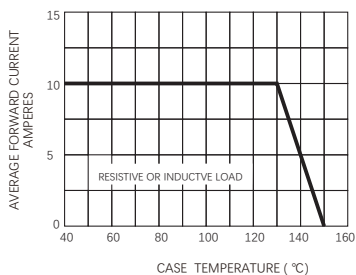

FIG.2-MAXIMUM NON-REPETITIVE PEAK FORWARD SURGE CURRENT

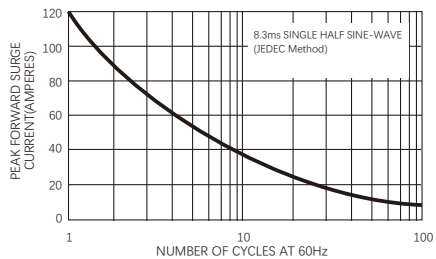

FIG.3-TYPICAL INSTANTANEOUS FORWARD CHARACTERISTICS

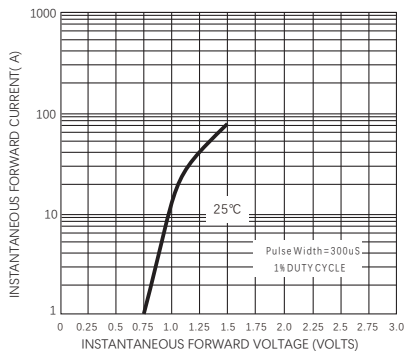
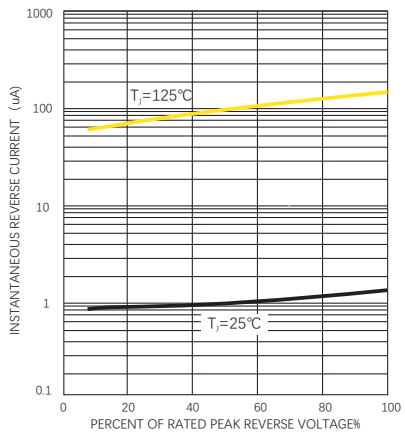
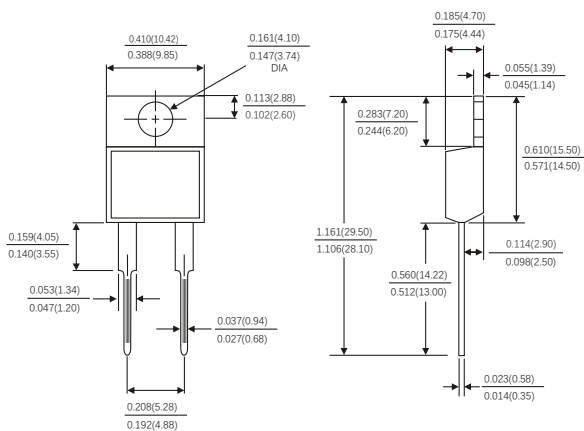

FIG.4-TYPICAL REVERSE CHARACTERISTICS



TO-220AC



Dimensions in inches and (millimeters)

Friendship Reminder

- JiNan JingHeng(hereinafter referred to as JH) reserves the right to make changes to this document and its products and specifications at anytime without notice.
- Customers should obtain and confirm the latest product information and specifications before final design, purchase or use.
- JH makes no warranty, representation or guarantee regarding the suitability of its products for any particular purpose, nor does JH assume any liability for application assistance or customer product design.
- JH does not warrant or accept any liability with products which are purchased or used for any unintended or unauthorized application.
- No license is granted by implication or otherwise under any intellectual property rights of JH.
- JH's products are not authorized for use as critical components in life support devices or systems without express written approval of JH.