

# MURF1020 THRU MURF1060

## GLASS PASSIVATED SUPER FAST RECTIFIER

Reverse Voltage - 200 -600 Volts

Forward Current - 10.0Amperes



SEMICONDUCTOR

### FEATURES

- Plastic package has Underwriters Laboratory Flammability Classification 94V-0
- Fast switching for high efficiency
- Low forward voltage drop
- Single rectifier construction
- High surge capability
- For use in low voltage ,high frequency inverters, free wheeling ,and polarity protection applications
- High temperature soldering guaranteed:260°C/10 seconds, 0.25"(6.35mm)from case
- Component in accordance to RoHS 2011/65/EU

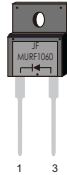

### ITO-220AC

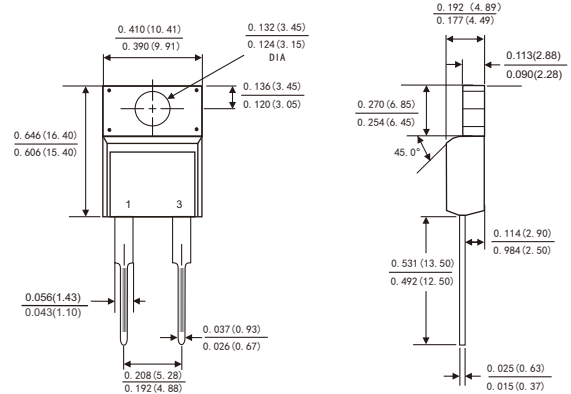

### MECHANICAL DATA

- Case: JEDEC ITO-220AC molded plastic body
- Terminals: Lead solderable per MIL-STD-750,method 2026
- Polarity: As marked
- Mounting Position: Any
- Weight: 0.08ounce, 2.24 gram

Dimensions in inches and (millimeters)

### MAXIMUM RATINGS AND ELECTRICAL CHARACTERISTICS

(Ratings at 25°C ambient temperature unless otherwise specified ,Single phase ,half wave ,resistive or inductive load. For capacitive load,derate by 20%.)

Parameters	Symbols	MURF 1020	MURF 1040	MURF 1060	Units
Maximum repetitive peak reverse voltage	$V_{RRM}$	200	400	600	Volts
Maximum RMS voltage	$V_{RMS}$	140	280	420	Volts
Maximum DC blocking voltage	$V_{DC}$	200	400	600	Volts
Maximum average forward rectified current(see Fig.1)	$I_{(AV)}$	10.0			Amps
Peak forward surge current 8.3ms single half sine-wave superimposed on rated load (JEDEC method)	$I_{FSM}$	120			Amps
Maximum instantaneous forward voltage at 10.0 A(Note 1)	$V_F$	0.975	1.3	1.7	Volts
Maximum instantaneous reverse current at rated DC blocking voltage(Note 1)	$T_a=25^{\circ}C$	$I_R$	5		$\mu A$
	$T_a=125^{\circ}C$		50		
Maximum Reverse Recovery Time (Note 2)	$T_{rr}$	35			ns
Typical thermal resistance (Note 3)	$R_{\theta JC}$	3.0			$^{\circ}C/W$
Typical Junction Capacitance(Note4)	$C_j$	63			pF
Operating junction temperature range	$T_J$	-55 to+150			$^{\circ}C$
Storage temperature range	$T_{STG}$	-55 to+150			$^{\circ}C$

- Notes:**
1. Pulse test: 300 $\mu$ s pulse width, 1% duty cycle
  2. Reverse recovery test conditions  $I_F=0.5A, I_R=1.0A, I_{rr}=0.25A$
  3. Thermal resistance from junction to case
  4. Measured at 1MHZ and applied reverse voltage of 4.0 Volts.

# RATINGS AND CHARACTERISTIC CURVES MURF1020 THRU MURF1060

FIG.1-FORWARD CURRENT DERATING CURVE

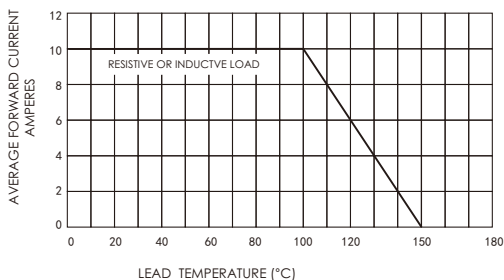

FIG.2-MAXIMUM NON-REPETITIVE PEAK FORWARD SURGE CURRENT

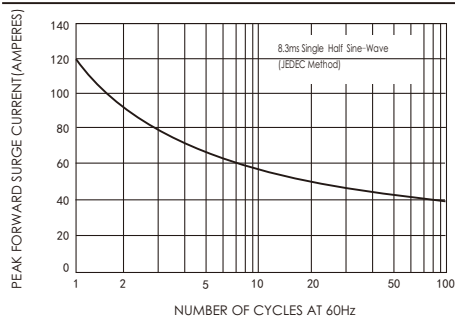

FIG.3-TYPICAL INSTANTANEOUS FORWARD CHARACTERISTICS

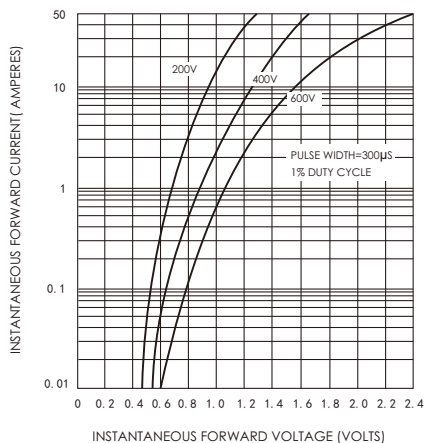

FIG.4-TYPICAL REVERSE CHARACTERISTICS

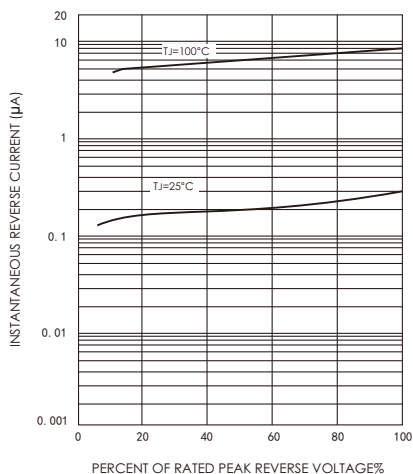

FIG.5-TYPICAL JUNCTION CAPACITANCE

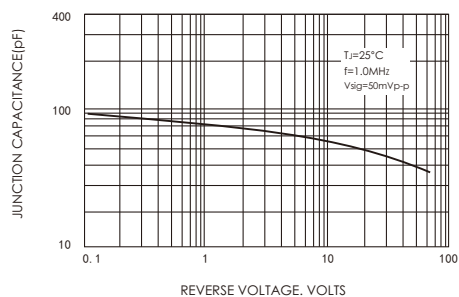

FIG.6-TYPICAL TRANSIENT THERMAL IMPEDANCE

