

FEATURES

- Plastic package has Underwriters Laboratory Flammability Classification 94V-0
- Fast switching for high efficiency
- Low forward voltage drop
- Single rectifier construction
- High surge capability
- For use in low voltage ,high frequency inverters, free wheeling ,and polarity protection applications
- High temperature soldering guaranteed:260°C/10 seconds, 0.25"(6.35mm)from case
- Component in accordance to RoHS 2011/65/EU

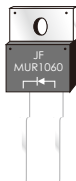

TO-220AC

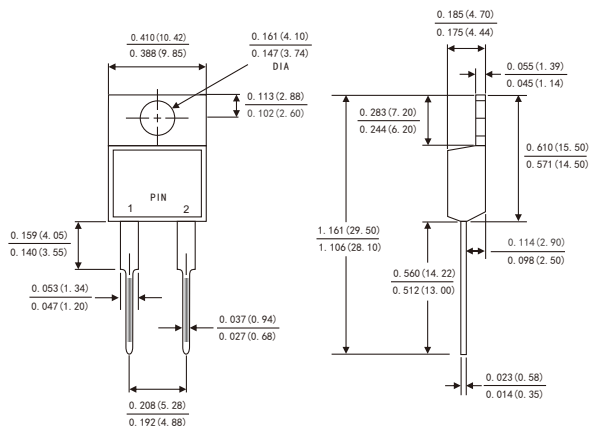

Dimensions in inches and (millimeters)

MECHANICAL DATA

- Case: JEDEC TO-220AC molded plastic body
- Terminals: Lead solderable per MIL-STD-750,method 2026
- Polarity: As marked
- Mounting Position: Any
- Weight: 0.08ounce, 2.24 gram

MAXIMUM RATINGS AND ELECTRICAL CHARACTERISTICS

(Ratings at 25°C ambient temperature unless otherwise specified ,Single phase ,half wave ,resistive or inductive load. For capacitive load,derate by 20%.)

	Symbols	MUR 1020	MUR 1040	MUR 1060	Units
Maximum repetitive peak reverse voltage	V_{RRM}	200	400	600	Volts
Maximum RMS voltage	V_{RMS}	140	280	420	Volts
Maximum DC blocking voltage	V_{DC}	200	400	600	Volts
Maximum average forward rectified current(see Fig.1)	$I_{(AV)}$	10.0			Amps
Peak forward surge current 8.3ms single half sine-wave superimposed on rated load (JEDEC method)	I_{FSM}	120			Amps
Maximum instantaneous forward voltage at 10.0 A(Note 1)	V_F	0.975	1.3	1.7	Volts
Maximum instantaneous reverse current at rated DC blocking voltage(Note 1)	$T_A=25^{\circ}C$	I_R	5		μA
	$T_A=125^{\circ}C$		50		
Maximum Reverse Recovery Time (Note 2)	T_{rr}	35			ns
Typical thermal resistance (Note 3)	$R_{\theta JC}$	2.5			$^{\circ}C/W$
Typical Junction Capacitance(Note4)	C_j	63			pF
Operating junction temperature range	T_J	-55 to+150			$^{\circ}C$
Storage temperature range	T_{STG}	-55 to+150			$^{\circ}C$

- Notes:**
1. Pulse test: 300 μ s pulse width,1% duty cycle
 2. Reverse recovery test conditions $I_F=0.5A,I_R=1.0A,I_{rr}=0.25A$
 3. Thermal resistance from junction to case
 - 4.Measured at 1MHZ and applied reverse voltage of 4.0 Volts.

RATINGS AND CHARACTERISTIC CURVES MUR1020 THRU MUR1060

FIG.1-FORWARD CURRENT DERATING CURVE

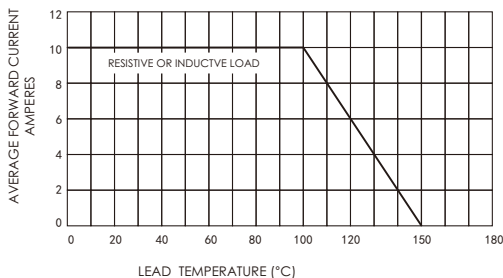

FIG.3-TYPICAL INSTANTANEOUS FORWARD CHARACTERISTICS

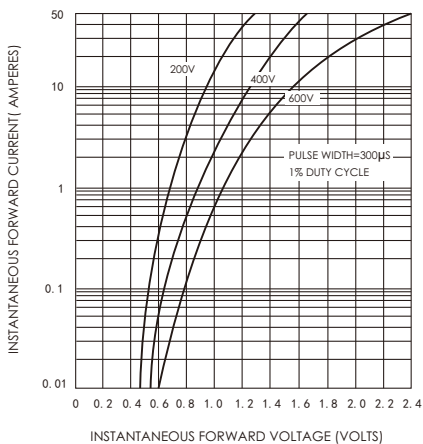

FIG.5-TYPICAL JUNCTION CAPACITANCE

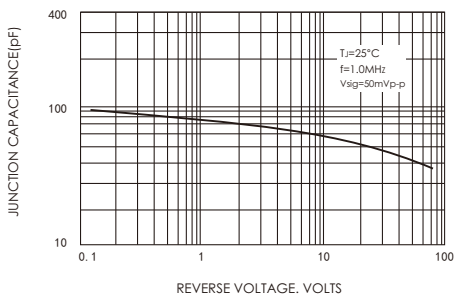

FIG.2-MAXIMUM NON-REPETITIVE PEAK FORWARD SURGE CURRENT

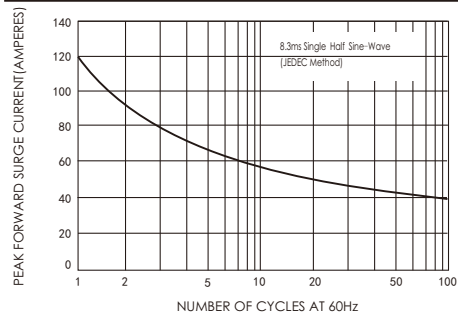

FIG.4-TYPICAL REVERSE CHARACTERISTICS

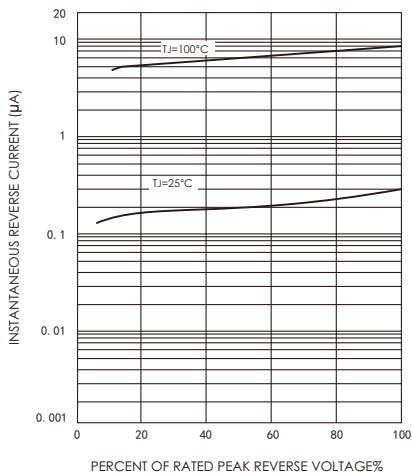

FIG.6-TYPICAL TRANSIENT THERMAL IMPEDANCE

