

U1A THRU U1M

GLASS PASSIVATED JUNCTION
HIGH EFFICIENCY RECTIFIER
Reverse Voltage: 50 to 1000 Volts
Forward Current: 1.0 Ampere

FEATURES

- Plastic package has Underwriters Laboratory Flammability Classification 94V-0
- Glass passivated junction
- Low forward voltage drop
- High current capability, High reliability
- Low power loss, high efficiency
- High surge current capability
- High speed switching, Low leakage
- High temperature soldering guaranteed: 260°C/10 seconds at terminals
- Component in accordance to RoHS 2011/65/EU



MECHANICAL DATA

- Case: SOD-123FL molded plastic
- Terminals: Solder plated, solderable per MIL-STD-750, Method 2026
- Polarity: Color band denotes cathode end
- Mounting Position: Any

SOD-123FL

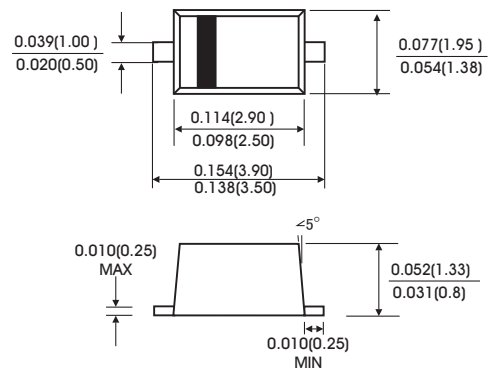

Dimensions in inches and (millimeters)

MAXIMUM RATINGS AND ELECTRICAL CHARACTERISTICS

(Rating at 25°C ambient temperature unless otherwise specified. Single phase, half wave, 60Hz, resistive or inductive load. For capacitive load, derate current by 20%.)

	Symbols	U1A	U1B	U1D	U1F	U1G	U1J	U1K	U1M	Units	
Maximum Recurrent Peak Reverse Voltage	V_{RRM}	50	100	200	300	400	600	800	1000	Volts	
Maximum RMS Voltage	V_{RMS}	35	70	140	210	280	420	560	700	Volts	
Maximum DC Blocking Voltage	V_{DC}	50	100	200	300	400	600	800	1000	Volts	
Maximum Average Forward Rectified Current	$I_{(AV)}$	1.0								Amp	
Peak Forward Surge Current 8.3ms single half sine-wave superimposed on rated load (JEDEC method)	I_{FSM}	30.0								Amps	
Maximum Instantaneous Forward Voltage at 1.0 A	V_F	1.0			1.3		1.7			Volts	
Maximum DC Reverse Current at rated DC blocking voltage	$T_A=25^\circ\text{C}$	5.0								μA	
	$T_A=125^\circ\text{C}$	100									
Typical Thermal resistance	$R_{\theta JA}$	170								$^\circ\text{C}/\text{W}$	
	$R_{\theta JL}$	55									
Maximum reverse recovery time(Note1)	T_{rr}	50					75				ns
Typical junction capacitance(Note2)	C_J	15								PF	
Operating junction and storage temperature range	T_J T_{STG}	-55 to +150								$^\circ\text{C}$	

Note: 1. Test conditions: $I_F=0.5\text{A}$, $I_R=1.0\text{A}$, $I_{RR}=0.25\text{A}$.

2. Measured at 1MHz and applied reverse voltage of 4.0 Volts.

RATINGS AND CHARACTERISTIC CURVES U1A THRU U1M

FIG.1-TEST CIRCUIT DIAGRAM AND REVERSE RECOVERY TIME CHARACTERISTIC

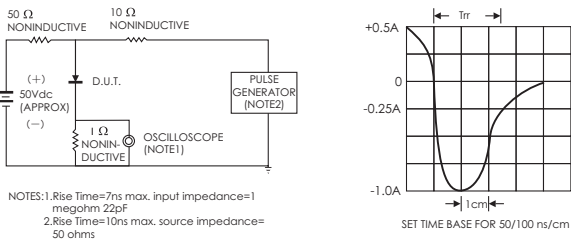

FIG.2-TYPICAL FORWARD CURRENT DERATING CURVE

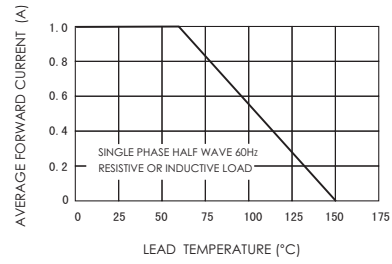

FIG.3-TYPICAL INSTANTANEOUS FORWARD CHARACTERISTICS

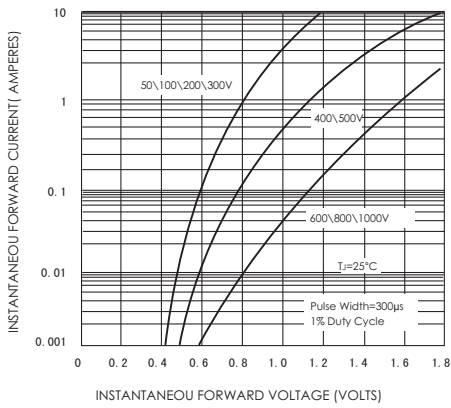

FIG.4-TYPICAL REVERSE CHARACTERISTICS

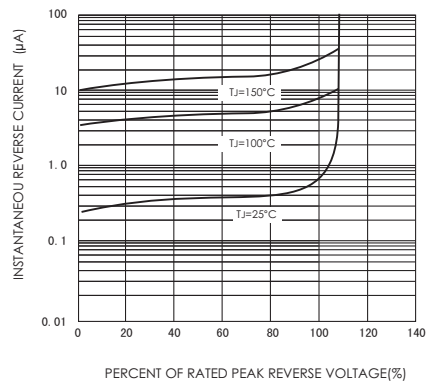

FIG.5-MAXIMUM NON-REPETITIVE FORWARD SURGE CURRENT

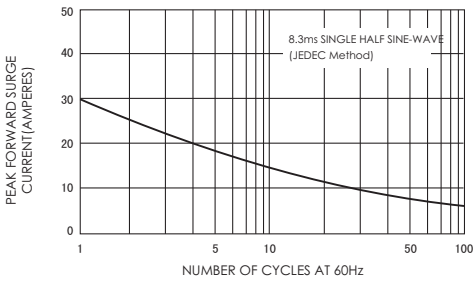

FIG.6-TYPICAL JUNCTION CAPACITANCE

