

FEATURES

- Plastic package has Underwriters Laboratory Flammability Classification 94V-0
- Metal silicon junction ,majority carrier conduction
- Guard ring for overvoltage protection
- Low power loss ,high efficiency
- High current capability ,low forward voltage drop
- High surge capability
- High temperature soldering guaranteed:260°C/10 seconds at terminals
- Component in accordance to RoHS 2015/863/EU

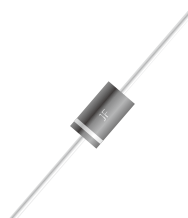

DO-201AD

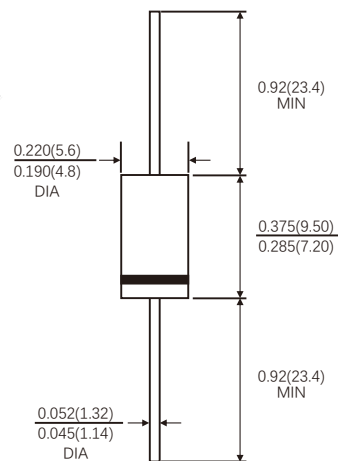

MECHANICAL DATA

- Case: JEDEC DO-201AD molded plastic body
- Terminals: Plated axial leads, solderable per MIL-STD-750,method 2026
- Polarity: color band denotes cathode end
- Mounting Position: Any
- Weight: 0.041ounce, 1.15 grams

TYPICAL APPLICATIONS

For use in low voltage ,high frequency inverters ,DC/DC converters, free wheeling ,and polarity protection applications

MAXIMUM RATINGS

(Ratings at 25°C ambient temperature unless otherwise specified)

PRIMARY CHARACTERISTICS	
$I_{F(AV)}$	5.0A
V_{RRM}	100V
I_{FSM}	80A
V_F at $I_F=3.0A, 25^\circ C$	0.55V
T_{JMAX}	150°C

Parameter	Symbol	Value	Unit
Maximum repetitive peak reverse voltage	V_{RRM}	100	V
Maximum average forward rectified current 0.375"(9.5mm) lead length(see fig.1)	$I_{F(AV)}$	3.0	A
Peak forward surge current 8.3ms single half sine-wave superimposed on rated load (JEDEC method at rated TL)	I_{FSM}	80	A
Operating junction temperature range	T_J	-55 to+150	°C
Storage temperature range	T_{stg}	-55 to+150	°C

ELECTRICAL CHARACTERISTICS (T_A=25°C Unless otherwise noted)

Parameter	Test Conditions		Symbol	Typ.	Max.	Unit
Instantaneous forward voltage	I _F =3.0A	T _J =25°C	V _F ¹⁾	0.55	0.62	V
		T _J =100°C		0.52	-	
		T _J =125°C		0.50	-	
	I _F =1.0A	T _J =25°C		0.45	-	
		T _J =100°C		0.37	-	
		T _J =125°C		0.34	-	
Reverse current	V _R =100V	T _J =25°C	I _R ²⁾	10	50	μA
		T _J =100°C		-	5	mA
		T _J =125°C		-	20	
Typical junction capacitance	4V,1MHz		C _J	370		pF

Notes: 1.Pulse test: 300 μs pulse width,1% duty cycle

2.Pulse test: pulse width ≤40ms

THERMAL CHARACTERISTICS

Parameter	Symbol	DO-201AD	Unit
Typical thermal resistance ³⁾	R _{θJA}	25.0	°C/W
	R _{θJL}	8.0	

3.Thermal resistance from junction to lead vertical P.C.B. mounted , 0.375"(9.5mm)lead length

AVAILABLE PACK INFORMATION

Product code	Pack	Box Size L*W*H(mm)	Quantity(pcs/box)	Carton SizeL*W*H(mm)	Quantity(box/carton)
SR3100L-DO-201AD	B/P	190*80*21	200	433*203*230	50
SR3100L-DO-201AD	T/B	264*74*135	1000	400*267*286	10

RATINGS AND CHARACTERISTIC OF SR3100L

FIG.1-FORWARD CURRENT DERATING CURVE

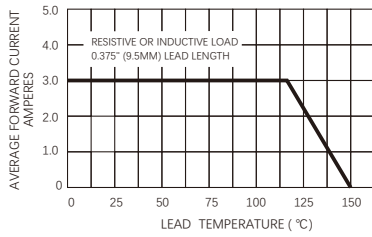

FIG.3-TYPICAL INSTANTANEOUS FORWARD CHARACTERISTICS

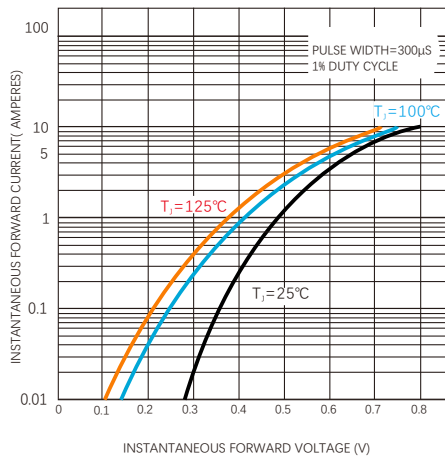

FIG.5-TYPICAL JUNCTION CAPACITANCE

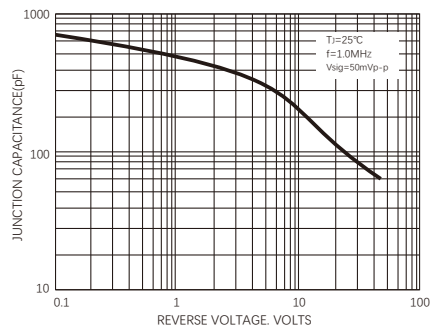

FIG.2-MAXIMUM NON-REPETITIVE PEAK FORWARD SURGE CURRENT

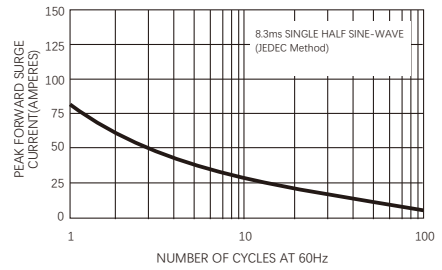
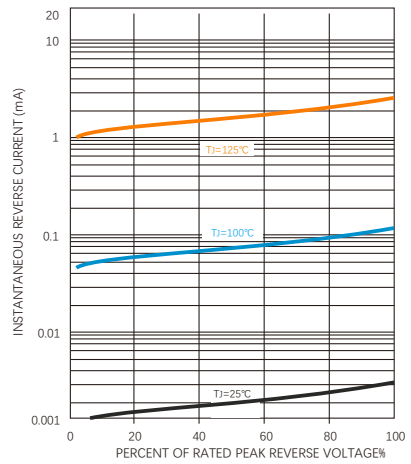

FIG.4-TYPICAL REVERSE CHARACTERISTICS



Friendship Reminder

- JiNan JingHeng (hereinafter referred to as JH) reserves the right to make changes to this document and its products and specifications at anytime without notice.
- Customers should obtain and confirm the latest product information and specifications before final design, purchase or use.
- JH makes no warranty, representation or guarantee regarding the suitability of its products for any particular purpose, nor does JH assume any liability for application assistance or customer product design.
- JH does not warrant or accept any liability with products which are purchased or used for any unintended or unauthorized application.
- No license is granted by implication or otherwise under any intellectual property rights of JH.
- JH's products are not authorized for use as critical components in life support devices or systems without express written approval of JH.